

# ME-50

## GUITAR MULTIPLE EFFECTS

# SERVICE NOTES

*Issued by RJA*

### TABLE OF CONTENTS

SPECIFICATIONS.....	2	RESTORING THE FACTORY SETTINGS.....	13
LOCATION OF CONTROLS .....	4	TEST MODE.....	13
LOCATION OF CONTROLS PARTS LIST .....	4	BLOCK DIAGRAM.....	20
EXPLODED VIEW .....	6	CIRCUIT BOARD.....	22
EXPLODED VIEW PARTS LIST .....	8	CIRCUIT BOARD.....	24
PARTS LIST.....	10	CIRCUIT DIAGRAM.....	26
CHECKING THE VERSION NUMBER.....	13		

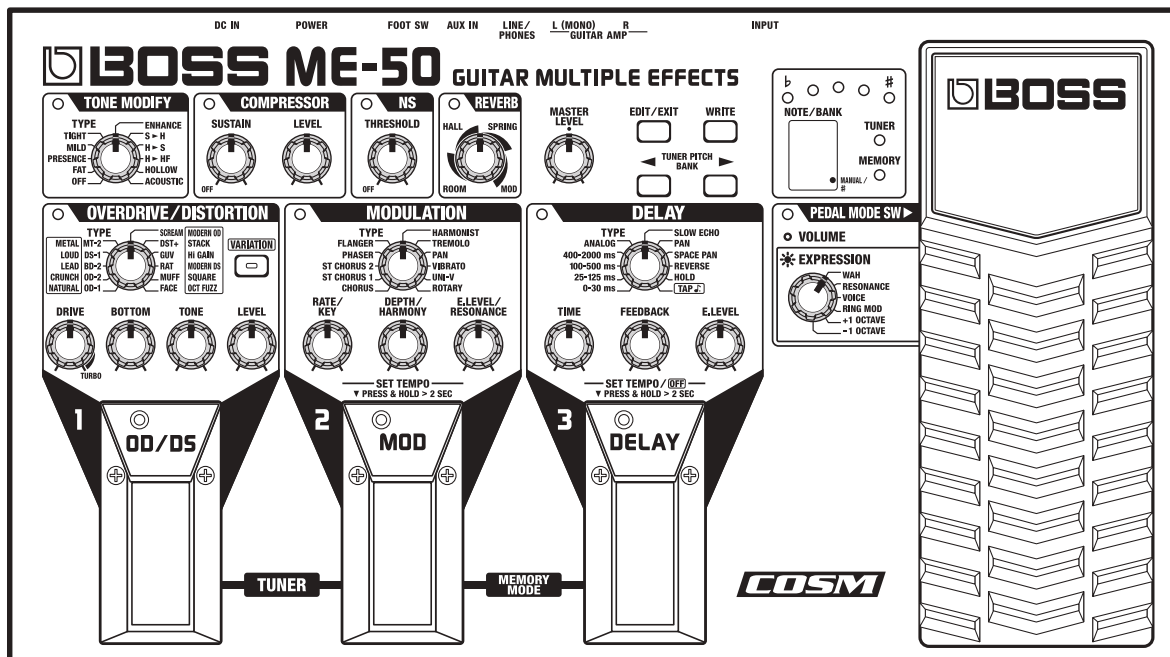

**Copyright © 2003 ROLAND CORPORATION**

All rights reserved. No part of this publication may be reproduced in any form without the written permission of ROLAND CORPORATION.

# SPECIFICATIONS

ME-50: Guitar Multiple Effects

## AD Conversion

24 bit + AF method (\*)

## DA Conversion

24 bit

## Sampling Frequency

44.1 kHz

## Patches

30 (user)

## Effects

Tone Modify  
Compressor  
Overdrive/Distortion  
Chorus  
Phaser  
Flanger  
Harmonist  
Tremolo  
Pan  
Vibrato  
UNI-V  
Rotary  
Delay  
Reverb  
Noise Suppressor  
(Effects for Expression Pedal)  
Foot Volume  
Wah  
Resonance  
Voice  
Ring Modulator  
Bend (+1 OCTAVE, -1 OCTAVE)

## Nominal Input Level

INPUT: -10 dBu  
AUX IN: -10 dBu

## Input Impedance

INPUT: 1 M ohms  
AUX IN: 100 k ohms

## Nominal Output Level

-10 dBu

## Output Impedance

2 k ohms

## Display

7 segments, 1 character LED

## Jacks

INPUT jack  
GUITAR AMP jacks L(MONO)/R  
AUX IN jack (Stereo Mini type)  
PHONES/LINE OUT jack  
AC Adaptor jack

## Power Supply

DC 9 V: Dry batteries (R6/LR6 (AA) type) x 6, AC Adaptor (PSA series: Optional)

## Current Draw

120 mA

\* *Expected battery life under continuous use:*

Carbon: 3.5 hours  
Alkaline: 12 hours

These figures will vary depending on the actual conditions of use.

## Dimensions

384 (W) x 225 (D) x 102 (H) mm  
15-1/8 (W) x 8-7/8 (D) x 4-1/16 (H) inches

## Weight

3.15 kg / 7 lbs (including batteries)

## Accessories

Owner's Manual ENGLISH :(#G6017362)  
JAPANESE :(#G6017361)

Dry Batteries (Alkaline: LR6 (AA) type) x 6:(#\*\*\*\*\*)

## Options

AC Adaptor: BOSS PSA series

Foot Switch: BOSS FS-5U

\*  $0 \text{ dBu} = 0.775 \text{ Vrms}$

\* *In the interest of product improvement, the specifications and/or appearance of this unit are subject to change without prior notice.*

\* *AF method (Adaptive Focus method)*

*This is a proprietary method from Roland that vastly improves the signal-to-noise (S/N) ratio of the A/D and D/A converters.*



# LOCATION OF CONTROLS

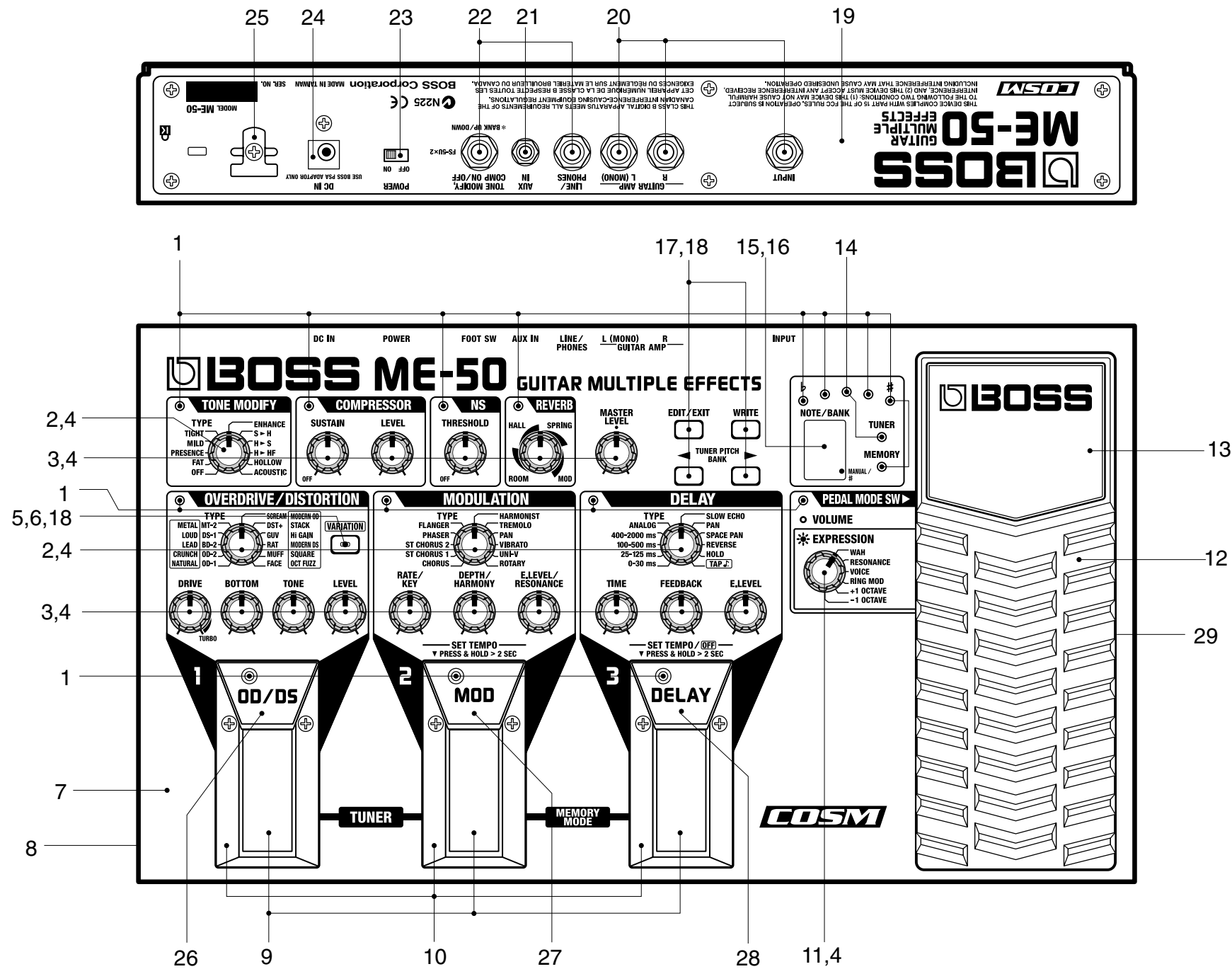

# LOCATION OF CONTROLS PARTS LIST

NO	PART CODE	PART NAME	DESCRIPTION	NO	PART CODE	PART NAME	DESCRIPTION
1	1502928100	LED (RED)	L-34HDSL	15	G2047001	7SEG COVER	
2	F3279803	POTENTIOMETER 11 CLICKS 50KB	RD901-40-125F-B54-11D	16	F5029408	LED	A-601H
3	F3279802	POTENTIOMETERNO CLICK 50KB	RD901-40-125F-B54-00D	17	G247751301	VGA KEYTOP S WITHOUT LENS	
4	G2477122	R-KNOB		18	F3129306	SWITCH	SKQKAB
5	F5029117	LED	L-312LRD	19	G1147002	REAR PANEL	
6	G247751001	VGA KEYTOP S BLACK WITH LENS		20	13449155MF	PHONE JACK (MONO)	HTJ-064-12I
7	G2027904	TOP COVER		21	13449440	JACK	HSJ0857-01-210
8	G2187193	BOTTOM COVER		22	13449150MF	PHONE JACK (STEREO)	HTJ-064-12D
9	G2187602	SWITCH PEDAL		23	F3159111	SLIDE SW	SK22F02
10	G2227301	PEDAL ESCUTCHEON		24	F3449717	JACK	HEC2392-01-150
11	F3279804	POTENTIOMETER 6 CLICKS	RD901-40-125F-B54-06D 50KB	25	F2367103	CORD HOOK	
12	G2187547	VR PEDAL		26	G2217733	PEDAL LABEL	(OD/DS)
13	G2357125	PEDAL PLATE		27	G2217734	PEDAL LABEL	(MOD)
14	15029106	LED	LD002VB	28	G2217735	PEDAL LABEL	(DELAY)
				29	F3279782	POTENTIOMETER	RK11K1140(10K SPECIAL B-CURVE)

# EXPLODED VIEW

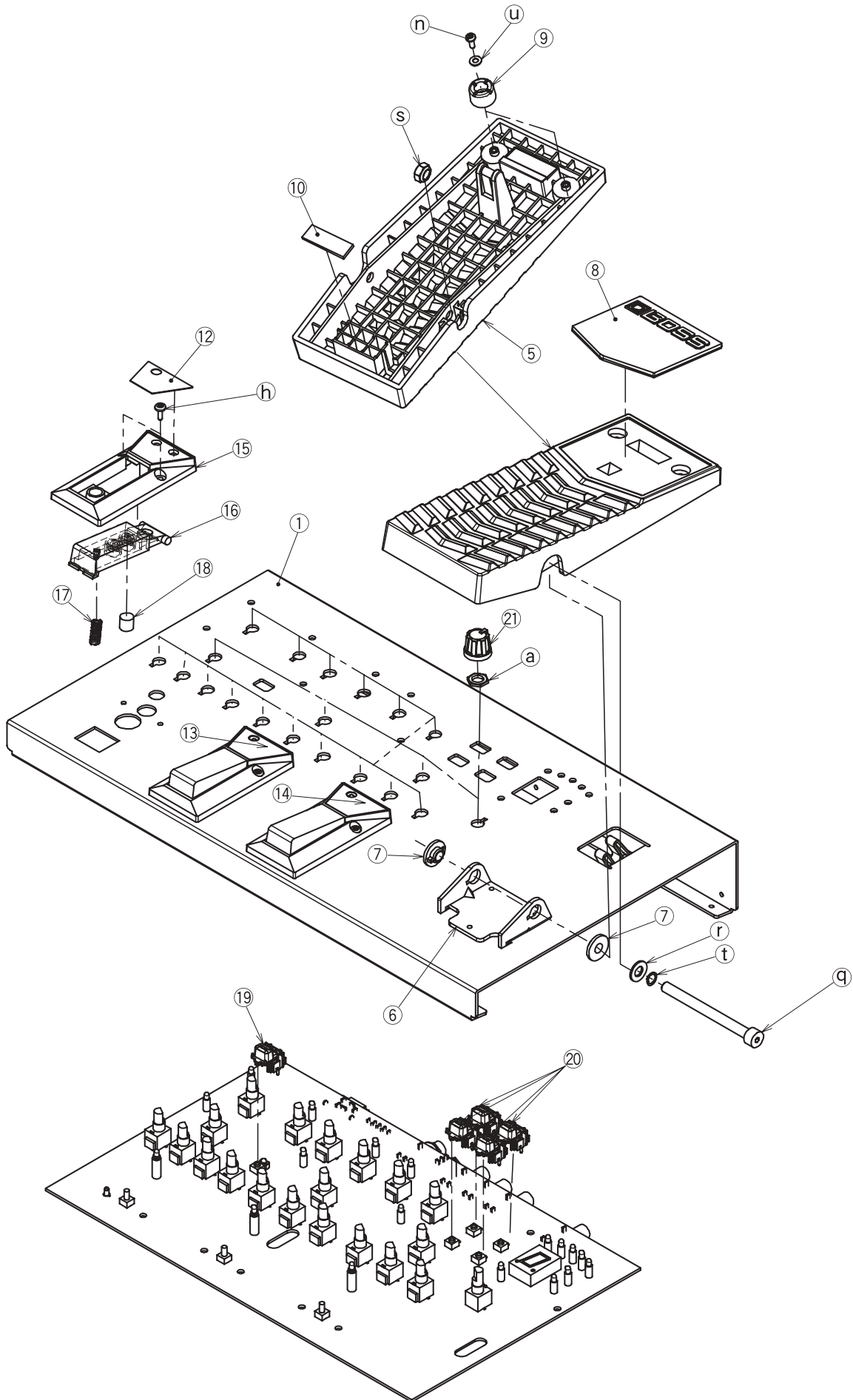

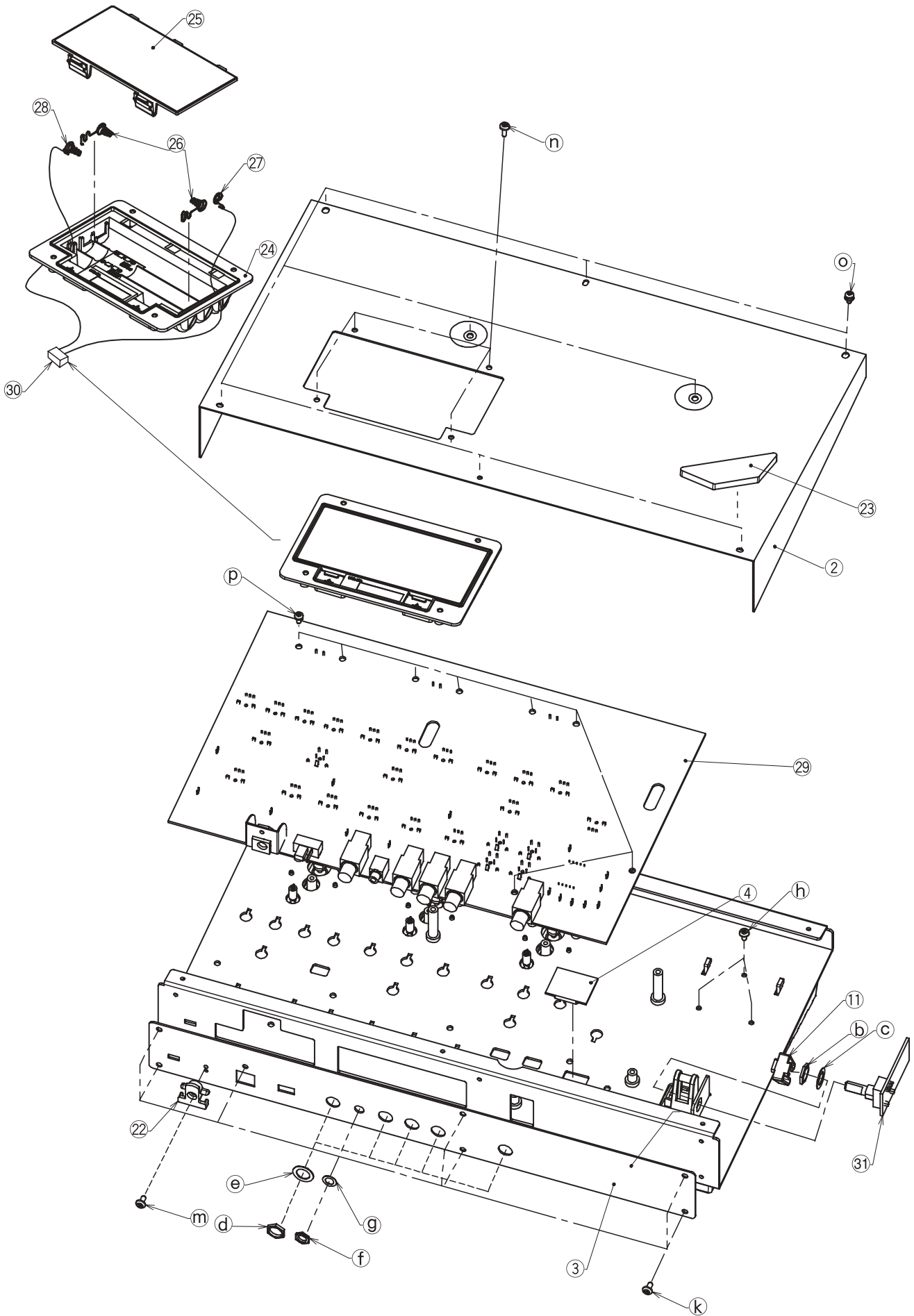

# EXPLODED VIEW PARTS LIST

## [PARTS]

NO	PART CODE	PART NAME	DESCRIPTION
1	G2027904	TOP COVER	
2	G2187193	BOTTOM COVER	
3	G1147002	REAR PANEL	
4	G2047001	7SEG COVER	
5	G2187547	VR PEDAL	
6	G2187910	PEDAL HOLDER	
7	G2147119	BOLT HOLDER	
8	G2357125	PEDAL PLATE	
9	G2357122	REAR CUSHION	
10	G2357111	CUSHION R	
11	G2147806	STAY	
12	G2217733	PEDAL LABEL	(OD/DS)
13	G2217734	PEDAL LABEL	(MOD)
14	G2217735	PEDAL LABEL	(DELAY)
15	G2227301	PEDAL ESCUTCHEON	
16	G2187602	SWITCH PEDAL	
17	G2177103	SUPPORT SPRING	
18	G2357126	PEDAL FOOT	H=7.6
19	G247751001	VGA KEYTOP S BLACK WITH LENS	
20	G247751301	VGA KEYTOP S WITHOUT LENS	
21	G2477122	R-KNOB	
22	F2367103	CORD HOOK	
23	G2357120	FOOT	H=5
24	G2017617	BATTERY CASE	
25	G2027602	BATTERY COVER	
26	G2177304	BATTERY TERMINAL (+ -)	
27	G2177305	BATTERY TERMINAL (+)	
28	G2177306	BATTERY TERMINAL (-)	
29	75E013P000	MAIN SHEET ASSY	
30	F3467025	WIRING 2P	
MAIN SHEET ASSY includes the following parts.			
31	*****	EXP BOARD ASSY	

## [SCREWS]

NO	PART CODE	PART NAME	DESCRIPTION
a	H5039521	VR ACCESSORY NUT M7	
b	H5039520	M9 NUT	
c	H5039126	M9 WASHER	
d	H5039514	NUT M6	HSJ-0999-01-190
e	H5039121	WASHER 9.5X6.5	HSJ-0999-01-210
f	H5039510	NUT M9X12X2	FENI
g	H5039112	WASHER M9	
h	H5029331	SCREW 3X8	BINDING S-TIGHT FEBC
k	H5029332	SCREW 3X6	BINDING S-TIGHT FEBZC
m	H5029308	SCREW 3X10	BINDING S-TIGHT FEBC
n	H5029330	SCREW M3X8	BINDING TAPTITE P BZC
o	H5019124	SCREW M3X6	PAN MACHINE W/SW+SMALL PW ZC
p	H5019130	SCREW M3X6	PAN MACHINE W/SW+PW ZC
q	H5029867	HEX BOLT M6X70	HALF THEREAD BZ
r	H5039122	PLAIN WASHER	6X13X1 BZC
s	H5039515	NUT M6	U BZC
t	H5019154	SPRING WASHER	6X12X1
u	H5039111	PLAIN WASHER 3X8	ZC





# PARTS LIST

**SAFETY PRECAUTIONS:**

The parts marked  $\Delta$  have safety-related characteristics. Use only listed parts for replacement.

**CONSIDERATION ON PARTS ORDRING**

When ordering any parts listed in the parts list, please specify the following items in the order sheet.

	QTY	PART NUMBER	DESCRIPTION	MODEL NUMBER
Ex.	10	22575241	Sharp Key	C-20/50
	15	2247017300	Knob (orange)	DAC-15D

Failure to completely fill the above items with correct number and description will result in delayed or even undelivered replacement.

NOTE: The parts marked # are new. (initial parts)

**CASING**

#	G2047001	7SEG COVER			1
	G2017617	BATTERY CASE			1
	G2027602	BATTERY COVER			1
#	G2187193	BOTTOM COVER			1
	G2227301	PEDAL ESCUTCHEON			3
#	G1147002	REAR PANEL			1
	G2187602	SWITCH PEDAL			3
#	G2027904	TOP COVER			1
#	G2187547	VR PEDAL			1

**CHASSIS**

#	G2187910	PEDAL HOLDER			
#	G2147806	STAY			1

**KNOB,BUTTON**

	G2357120	FOOT	H=5		4
#	F2367103	CORD HOOK			1
	G2477122	R-KNOB			20
	G247751001	VGA KEYPAD S BLACK WITH LENS			1
	G247751301	VGA KEYPAD S WITHOUT LENS			4

**SWITCH**

	13129778	SKQKAH	TACT SWITCH	SW7,8,9	3
#	F3129306	SKQKAB	SWITCH	SW1,2,3,4,6	5
#	F3159111	SK22F02	SLIDE SW	SW5	1

**JACK,EXT TERMINAL**

	13449150MF	HTJ-064-12D	PHONE JACK (STEREO)	JK6,4	2
	13449155MF	HTJ-064-12I	PHONE JACK (MONO)	JK1,2,3	3
#	F3449717	HEC2392-01-150	JACK	JK7	1
	13449440	HSJ0857-01-210	JACK	JK5	1

**PWB ASSY**

#	75E013P000	MAIN SHEET ASSY			1
---	------------	-----------------	--	--	---

**IC**

	01672634	TC74HC4052AFT(EL)	IC TTL	IC4,7,10	3
	15209102	M51957BFP	IC (SYSTEM RESET)	IC3	1
#	F5199110	S-81233SGY	IC (REGURATOR)	IC19	1
#	F5289101	NJM2100M 8P SOP	IC (OP.AMP)	IC2	1
#	03123889	HD6433687	IC (MASK CPU)	IC11	1
#	F5279309	BU2090F-E2	IC (LED DRIVER)	IC16,17	2
#	F5179607	CAT24WC32J	IC (EEPROM)	IC15	1
	02231767	RA0A-101 (TC223C080AF-101)	IC (DSP)	IC8	1
#	F5279520	LC32V4265T-25-TLM	IC (DRAM)	IC12	1
#	03123901	LT1616	IC (DC-DC)	IC14	1
	15189261	M5218AFP-600E	IC (BIPOLAR OP AMP)	IC1,5,18	3
	01125012	NJM4556AM	IC (BIPOLAR OP AMP)	IC6	1
	02451434	AK4552VT	IC (AD/DA)	IC3	1

**TRANSISTOR**

	15309104	2SA1586-GR(TE85R)	TRANSISTOR	Q6	1
	15319107	2SC4116-GR(TE85R)	TRANSISTOR	Q9	1
	15319115	2SC4213-A(TE85L)	TRANSISTOR	Q2,3,4,5	4
	15329103	2SK880GR-TE85R	FET TRANSISTOR	Q1	1

<b>DIODE</b>					
	1502928100	L-34HDSL	LED (RED)	LED2,3,6,7,9,10,11,12,13,14,15,16,17,19,20,21	16
	15029106	LD002VB	LED	LED4,8	2
#	F5029408	A-601H	LED	LED5	1
	F5029117	L-312LRD	LED	LED18	1
	15339119	1SS-352	DIODE	D1,3,5,6	4
	F5339137	SS14 VF=0.45V	DIODE	D4,7	2
<b>RESISTOR</b>					
	F5419707	CRN34101J	RESISTOR ARRAY	RA1,2,3,4,6	5
	F5419705	CRN34103J	RESISTOR ARRAY	RA7,9	2
	F5419726	CRN34473J	RESISTOR ARRAY	RA8,10,11	3
#	F5429366	15K OHM F RANK (1%)	RESISTOR (CHIP)	R79	1
	F5399914	6.8KF	RESISTOR	R82	1
	F5399951	68(1/2W) CHIP	RESISTOR	R39,52	2
	F2569127	MINISMDC075	POLY SWITCH	R80	1
	00566867	RPC05T 100 J	MTL.FILM RESISTOR	R33,70	2
	00567023	RPC05T 101 J	MTL.FILM RESISTOR	R20,61,100	3
	00567156	RPC05T 102 J	MTL.FILM RESISTOR	R9,10,26,27	4
	00567289	RPC05T 103 J	MTL.FILM RESISTOR	R1,2,5,6,7,13,16,21,22,28,29,35,36,38,42,46,	30
	00567412	RPC05T 104 J	MTL.FILM RESISTOR	R12,63	18
	00567556	RPC05T 105 J	MTL.FILM RESISTOR	R12,R63	2
	00567167	RPC05T 122 J	MTL.FILM RESISTOR	R101	1
	00567290	RPC05T 123 J	MTL.FILM RESISTOR	R86,89	2
	00567301	RPC05T 153 J	MTL.FILM RESISTOR	R4	1
	00567190	RPC05T 222 J	MTL.FILM RESISTOR	R85	1
	00567078	RPC05T 271 J	MTL.FILM RESISTOR	R102,103,104,105,106,107,108,109	8
	00567334	RPC05T 273 J	MTL.FILM RESISTOR	R95,99	2
	00567089	RPC05T 331 J	MTL.FILM RESISTOR	R122	1
	00567345	RPC05T 333 J	MTL.FILM RESISTOR	R3,11,23,77,78,81,84,87,88,138,139,141,145,1	2
	00566967	RPC05T 470 J	MTL.FILM RESISTOR	R83,91	2
	00567112	RPC05T 471 J	MTL.FILM RESISTOR	R94,112	2
	00567245	RPC05T 472 J	MTL.FILM RESISTOR	R17,32,44,56,58,59,140,142	8
	00567378	RPC05T 473 J	MTL.FILM RESISTOR	R15,31,37,40,41,45,47,48,51,54,55,60,129,133	14
	00567256	RPC05T 562 J	MTL.FILM RESISTOR	R127,131	2
	00567134	RPC05T 681 J	MTL.FILM RESISTOR	R92,93,110,111,113,114,115,116,117,118,119,	16
				1	
	F5429365	10K OHM F RANK (1%)	CHIP RESISTOR	R24	1
	F5429386	150K F (1608TYPE)	CHIP RESISTOR	R18	1
<b>POTENTIOMETER</b>					
	F3279802	RD901-40-125F-B54-00D	POTENTIOMETERNO CLICK 50KB	VR3,4,6,7,8,10,11,12,13,14,15,18,19,20,21	15
	F3279804	RD901-40-125F-B54-06D 50KB	POTENTIOMETER 6 CLICKS	VR2	1
#	F3279803	RD901-40-125F-B54-11D	POTENTIOMETER 11 CLICKS 50KB	VR5,9,16,17	4
	F3279782	RK11K1140(10K SPECIAL B-CURVE	POTENTIOMETER	VR1	1
<b>CAPACITOR</b>					
	F5349704	ECPU1C474MA5 0.47	MYLAR CAPACITOR (SUBMICRON)	C4	1
	F3629110	100U/16V (H=7MM)	CHEMICAL CAPACITOR	C5,28,39,54,76,85,107,108,111,113,117,119,12	19
	F3629700	10U/16V (H=7MM)	CHEMICAL CAPACITOR	C2,9,10,11,12,16,19,20,22,23,24,25,31,42,49,	17
#	01674612	ECJ1VB1H103K	CERAMIC CAPACITOR	C116	1
	01674501	ECJ1VB1H182K	CERAMIC CAPACITOR	C37,53	2
	01674512	ECJ1VB1H222K	CERAMIC CAPACITOR	C1,7,14	3
	01674712	ECJ1VF1A105Z	CERAMIC CAPACITOR	C130	1
	01674701	ECJ1VF1E104Z 0.1UF/16VK	CERAMIC CAPACITOR	C18,26,29,30,32,34,38,45,46,47,48,59,60,61,6	58
	01674167	ECUV1H100DCV	CERAMIC CAPACITOR	C3,8,21,35,36,51,52,128,129	9
	01674467	ECUV1H102JCV	CERAMIC CAPACITOR	C95	1
	01674189	ECUV1H120JCV	CERAMIC CAPACITOR	C100,101	2
	01674356	ECUV1H151JCV	CERAMIC CAPACITOR	C44,58	2
#	F3629708	0.22U/50	CAPACITOR	C56,41	2
#	F3629701	1/50	CAPACITOR	C33	1
#	F3629703	47/16	CAPACITOR	C66	1
<b>INDUCTOR,COIL,FILTER</b>					
	F5409131	QT04-60	EMI	L1	1
#	F2449226	SLF7032T-100M 10UH	COIL	L3	1
<b>CRYSTAL,RESONATOR</b>					
	F5299306	HC-49SM 10.000MHZ	CRYSTAL	X1	1
	02672401	SG-8002JC 67.7376MHZ PC	CRYSTAL	X2	1
<b>CONNECTOR</b>					
	F3439123	A2001WR2-3P	CONNECTOR 3P	CN2	1
	F3439160	53015-0210 2P P=2MM	CONNECTOR	CN3	1

**WIRING,CABLE**

#	F3467025	WIRING 2P		1
#	F3467024	WIRING 3P		1

**SCREWS**

	H5039111	WASHER D8D3T0.5	ZC	2
#	H5039515	NUT M6	U BZC	1
	H5019124	SCREW M3X6	PAN MACHINE W/SW+SMALL PW ZC	8
	H5019130	SCREW M3X6	PAN MACHINE W/SW+PW ZC	8
#	H5039121	WASHER 9.5X6.5	HSJ-0999-01-210	
#	H5039514	NUT M6	HSJ-0999-01-190	
#	H5029867	HEX BOLT M6X70	HALF THEREAD BZ	1
	H5039510	NUT M9X12X2	FENI	for Phones Jack
#	H5029330	SCREW M3X8	BINDING TAPTITE P BZC	6
	H5029332	SCREW 3X6	BINDING S-TIGHT FEBZC	6
	H5029308	SCREW 3X10	BINDING S-TIGHT FEBC	1
	H5029331	SCREW 3X8	BINDING S-TIGHT FEBC	10
#	H5039122	PLAIN WASHER	6X13X1 BZC	1
#	H5019154	SPRING WASHER	6X12X1	1
	G2147119	BOLT HOLDER		2
	H5039520	M9 NUT		with VR RK11K1140
	H5039126	M9 WASHER		1
	H5039521	VR ACCESSORY NUT M7		with VR RD901-40
	H5039112	WASHER M9		for Phones Jack

**PACKING**

#	G2627753	PACKING CASE		1
#	G2267501	PAD L		1
#	G2267502	PAD R		1

**MISCELLANEOUS**

#	G2199505	LED SPACER	LED-7A	15
#	G2199506	LED SPACER	LED-15A	3
#	G2357126	PEDAL FOOT	H=7.6	3
#	G2217733	PEDAL LABEL	(OD/DS)	1
#	G2217734	PEDAL LABEL	(MOD)	1
#	G2217735	PEDAL LABEL	(DELAY)	1
	G2177304	BATTERY TERMINAL (+ -)		2
	G2177305	BATTERY TERMINAL (+)		1
	G2177306	BATTERY TERMINAL (-)		1
	G2357111	CUSHION R		1
	G2147127	DC JACK HOLDER		1
#	G2357125	PEDAL PLATE		1
	G2357122	REAR CUSHION		2
	G2177103	SUPPORT SPRING		3

**ACCESSORIES (Standard)**

#	G6017361	OWNER'S MANUAL	JAPANESE	
#	G6017362	OWNER'S MANUAL	ENGLISH	1
	40232389	WARRANTY CARD	FOR BOSS JAPAN ONLY	

## CHECKING THE VERSION NUMBER

- Device Settings

Turn the VR knobs (pots) completely to the left (minimum).

- Hold down the [EDIT/EXIT] switch and [WRITE] switch and turn the POWER switch on.

Press the [FOOT 1] switch.

If the version number is Ver.1.01, the “b” (flat symbol) LED lights up, and “1” appears in the seven-segment LED.

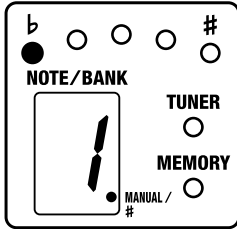

## RESTORING THE FACTORY SETTINGS

- Hold down the [WRITE] switch and [◀] switch and turn the POWER switch on.

“F” appears in the seven-segment LED.

- Press the [WRITE] switch. The BANK LED flashes.
- Press the [WRITE] switch. The seven-segment LED and BANK LED flash, and the factory data is loaded.

The dot in the seven-segment portion lights, and Factory Reset is completed when the unit switches to Play mode.



Never turn off the power while factory data is being loaded.

## TEST MODE

### Items to Have On Hand

Oscilloscope (1)  
Oscillator (1)  
Monitor amps (2)  
Noise meters (2)  
FS-5U (2)  
Open plug

### Measuring Equipment Settings

#### Oscillator

Waveform: Rectangular wave  
Frequency: 400 Hz  
Output Level: 50 mVp-p

#### Oscilloscope

TIME/DIV : 0.5 msec  
VOLTS/DIV : 0.2 V

### Noise Meter

Filter: IHF-A (JIS-A)

### Foot Switch (FS-5U)

POLARITY SW: Jack

## Switching into Test Mode

- Device Settings

Turn all VR knobs (pots) completely to the left (minimum).

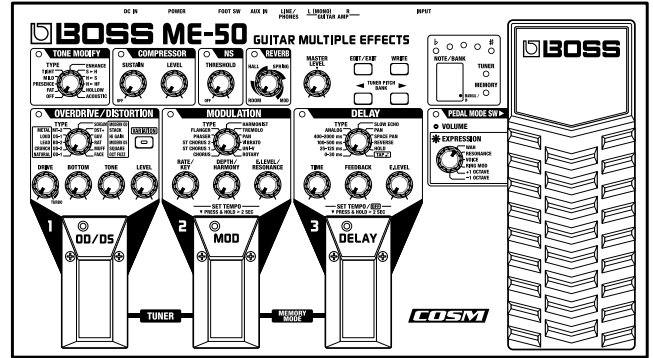

- Hold down the [EDIT/EXIT] switch and [WRITE] switch and turn the POWER switch on.

## Test Categories

1. LED Full Lighting, EEPROM Check
2. LED Lighting Check
3. Key SW, Pedal SW Check
4. External SW Check
5. VR Check
6. EXP Pedal Check
7. DSP Check
8. D/A Circuitry Check
9. DRAM Check
10. INPUT A/D Check, AUX IN Check, Noise Check
11. EXP Pedal Adjustment

## Test Details

Switch to Test mode.

- Device Settings

Turn all VR knobs (pots) completely to the left (minimum).

- Hold down the [EDIT/EXIT] switch and [WRITE] switch and turn the POWER switch on.

### 1. LED Full Lighting, EEPROM Check

- After the test is implemented, with data read from and written to the EEPROM, all of the LEDs light up.
- Confirm the following.

1. All LEDs are lit.
2. No LED goes off when the unit is subjected to shock.

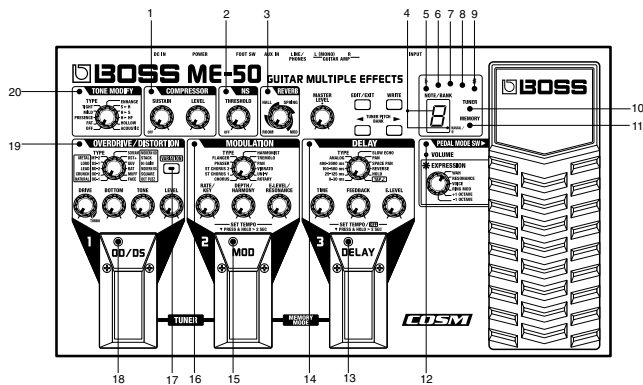

- With all LEDs lit, press the following switches to enable selection of the type of check to start.

Press the [FOOT 1] switch to proceed to the "Version Check."

Press the [FOOT 2] switch to proceed to "5. VR Check."

Press the [FOOT 3] switch to proceed to "6. EXP Pedal Check."

Press the [◀] switch to proceed to "7. DSP Check."

Press the [▶] switch to proceed to "11. EXP Pedal Adjustment."

- Version Check

Press the [FOOT 1] switch.

If the version number is Ver.1.01, the "b" (flat symbol) LED lights up, and "1" appears in the seven-segment LED.

After confirming the version, press the [▶] switch to proceed to the LED lighting check.

## 2. LED Lighting Check

- Confirm that the LEDs light up in sequence each the [WRITE] switch is pressed.

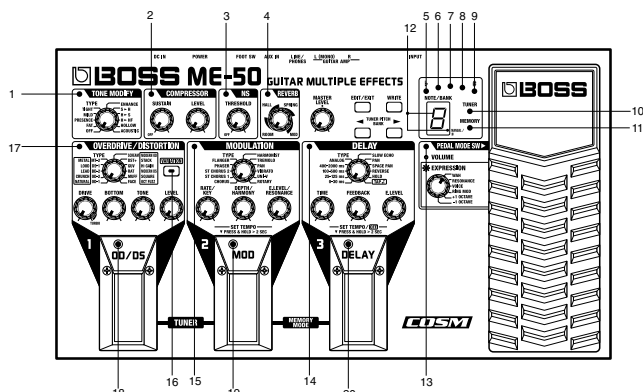

Sequence in Which LEDs Light Up

[TONE MODIFY]→[COMPRESSOR]→[NS]→[REVERB]→([b]→[#])  
 →[TUNER]→[MEMORY]  
 →[EACH SEGMENT OF 7-SEGMENT LED]→[PEDAL MODE SW]  
 →[DELAY]→[MODULATION]  
 →[OVERDRIVE/DISTORTION VARIATION]→[FOOT 1]→[FOOT 2]→[FOOT 3]  
 →RETURN TO [TONE MODIFY]

- Press the [▶] switch to proceed to the next step.

Note: This will not advance the procedure to the next step unless the cycle has returned to [TONE MODIFY].

## 3. Key SW, Pedal SW Check

- Press the following switches in the indicated sequence.

[WRITE]→[▶]→[EDIT/EXIT]→[◀]→[TYPE VARIATION]→[FOOT 1]→[FOOT 2]→[FOOT 3]

Note: If the incorrect key is pressed inadvertently, the procedure does not advance to the next key unless the correct key is pressed twice.

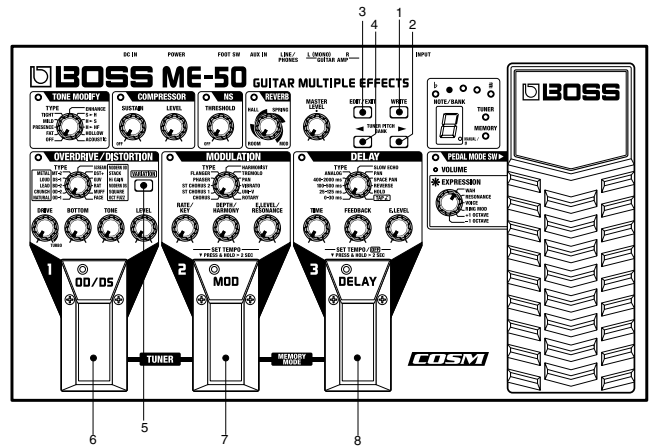

If no problem exists, the procedure automatically proceeds to the next step.

## 4. External SW Check

- Connect two FS-5U foot switches, one each to the [TONE MODIFY] and [COMP ON/OFF] jacks.

Set the FS-5U POLARITY switches at the jacks.

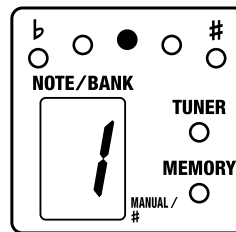

- Press the [TONE MODIFY] switch (FOOT SW = TIP).

If no problem exists, then "2" appears in the seven-segment display.

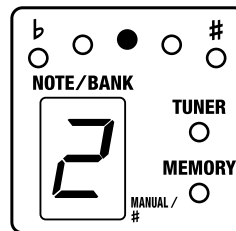

- Press the [COMP ON/OFF] switch (FOOT SW = RING).

If no problem exists, the procedure automatically proceeds to the next step.

## 5. VR Check

The dot in the seven-segment LED appears when the VR is not at the minimum position.

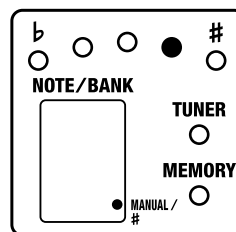

(1) Notched VR Check

- Rotate the following VRs in the indicated sequence.

[TONE MODIFY]→[OVERDRIVE/DISTORTION]→[MODULATION]→[DELAY]→[PEDAL MODE SW]

Note: The notched VRs turn in both directions (clockwise and counterclockwise).

Note: Confirm that what is displayed in the seven-segment LED changes with each notch position.

[TONE MODIFY], [OVERDRIVE/DISTORTION], [MODULATION], and [DELAY] = "0"--"A"

[PEDAL MODE SW] = "0"--"5"

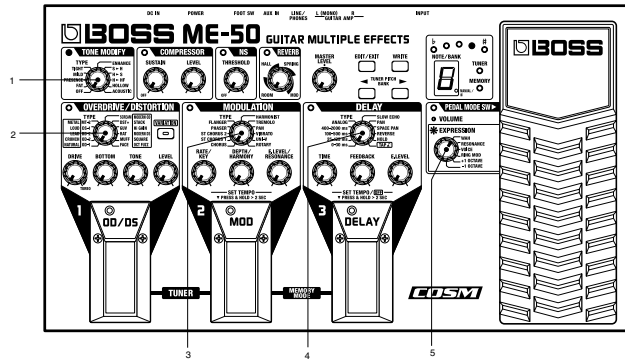

(2) Non-Notched VR Check

- Rotate the following VRs (pots) in the indicated sequence.  
 [COMPRESSOR:SUSTAIN]→[COMPRESSOR:LEVEL]→[NS:THRESHOLD]→  
 [REVERB]→[MASTER LEVEL]→[OVERDRIVE/DISTORTION:DRIVE]→  
 [OVERDRIVE/DISTORTION:BOTTOM]→  
 [OVERDRIVE/DISTORTION:TONE]→  
 [OVERDRIVE/DISTORTION:LEVEL]→[MODULATION:RATE/KEY]→  
 [MODULATION:DEPTH/HARMONY]→  
 [MODULATION:E.LEVEL/RESONANCE]→  
 [DELAY:TIME]→[DELAY:FEEDBACK]→[DELAY:E.LEVEL]

Note: Confirm that what is displayed in the seven-segment LED changes with each notch position.

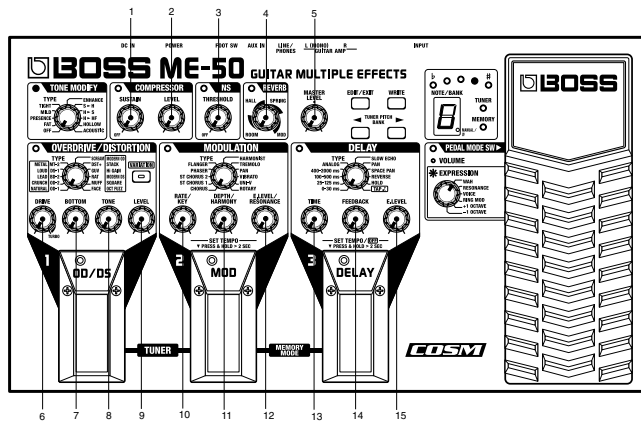
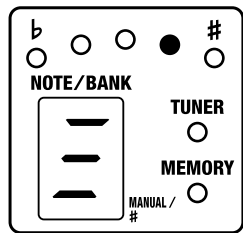
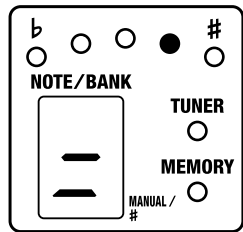
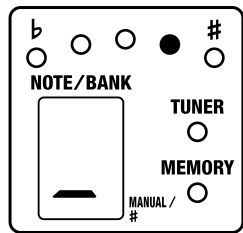

If no problem exists, the procedure automatically proceeds to the next step.

### 6. EXP Pedal Check

- Start with the expression pedal in the depressed position.
- Carry out the following operations in the indicated sequence.

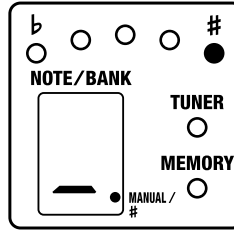

1. Raise the tip of the expression pedal until it is at its highest point.

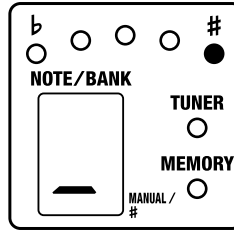

2. Lower the tip of the expression pedal until it is approximately at the midpoint.

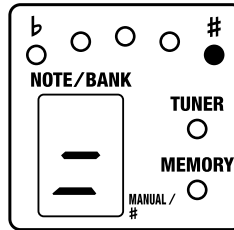

3. Once again, press down tip down completely so that the pedal is in the fully depressed position.

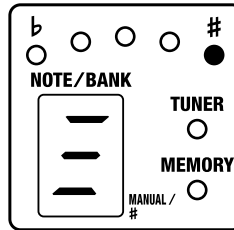

If no problem exists, the procedure automatically proceeds to the next step.

### 7. DSP Check

- The DSP check is performed automatically.
- If no problem exists, the procedure automatically proceeds to the next step.

### 8. D/A Circuitry Check

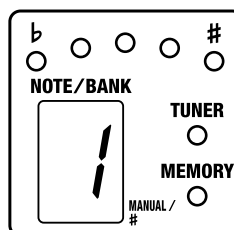

- Oscilloscope Settings: Ch1: 0.2 V/div; Ch2: 0.2 V/div; TIME: 0.5 ms/div
- Connect the cable only to the OUTPUT L(MONO) jack, then confirm that the waveform output by OUTPUT L(MONO) changes accordingly, as shown in the figures below.

[Mute Off]

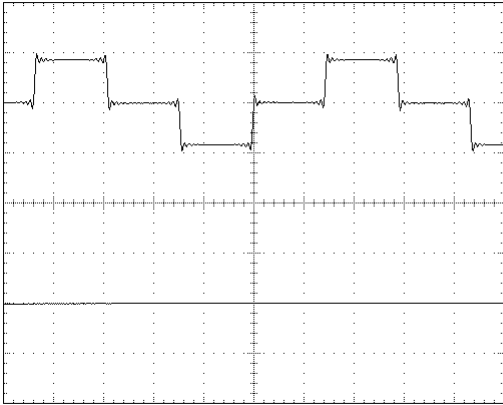

[Mute On]

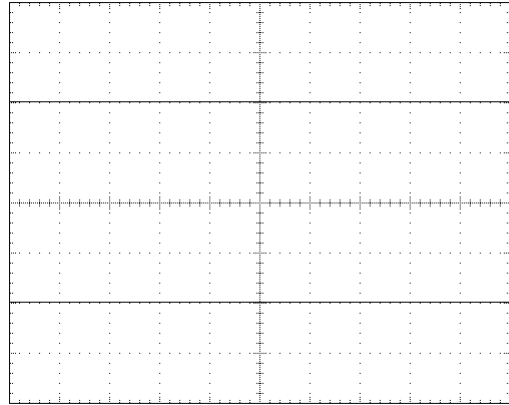

[Mute On]

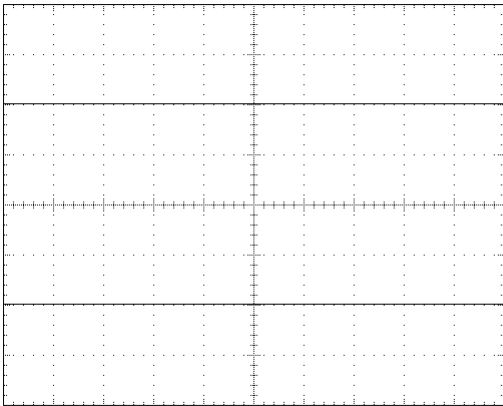

- Disconnect the cable from OUTPUT R, then confirm that the waveform output by OUTPUT L(MONO) changes accordingly, as shown in the figures below.

[Mute Off]

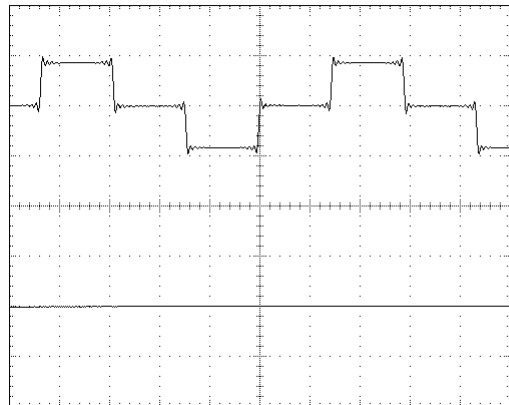

- Next, connect the cable to OUTPUT R, then confirm that the waveform output by OUTPUT R changes accordingly, as shown in the figures below.

[Mute Off]

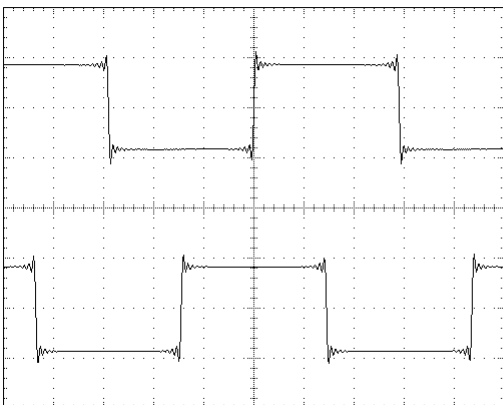

[Mute On]

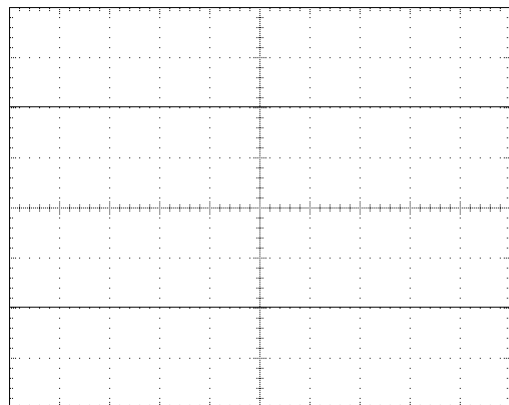

Reconnect the cable to OUTPUT R, then confirm that the waveform output by OUTPUT changes accordingly, as shown in the figures below.

[Mute Off]

- Confirm that the value for the waveform amplitude is between 380 and 540 (mVp-p).

[Mute On]

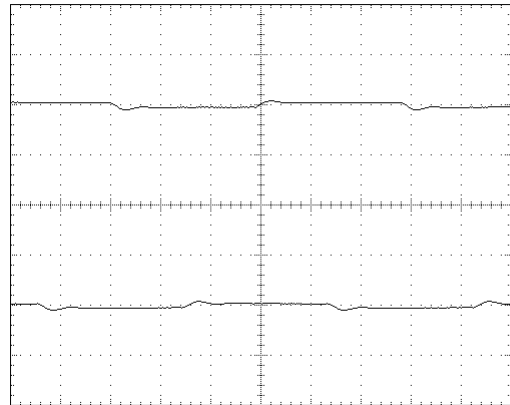
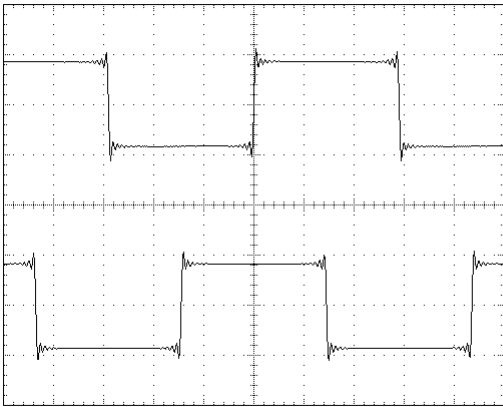

[Mute On]

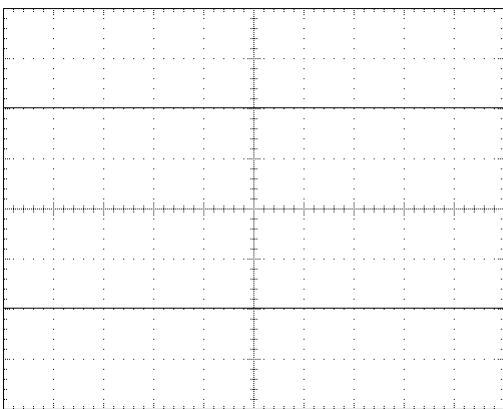

Press the [▶] switch to proceed to the next step.

9. DRAM Check

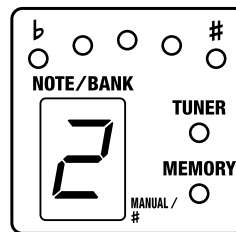

- Oscilloscope Settings: Ch1: 0.2 V/div; Ch2: 0.2 V/div; TIME: 0.5 ms/div
- Connect the cable only to the OUTPUT L(MONO) jack, then confirm that the waveform from OUTPUT is smooth, as shown in the figure below.
- Confirm that the value for the waveform amplitude is between 330 and 470 (mVp-p).

- Confirm that the LINE/PHONES waveform changes accordingly, as shown in the figures below.
- Confirm that the value for the waveform amplitude is between 600 and 850 (mVp-p).

[Mute Off]

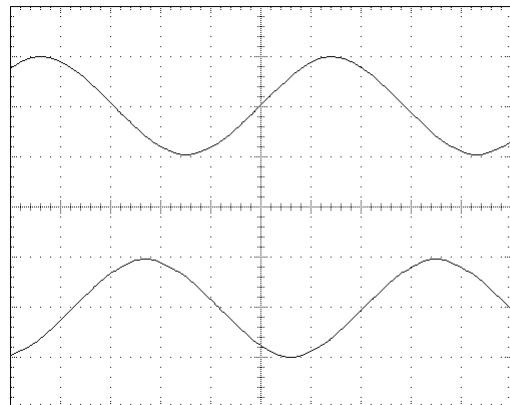
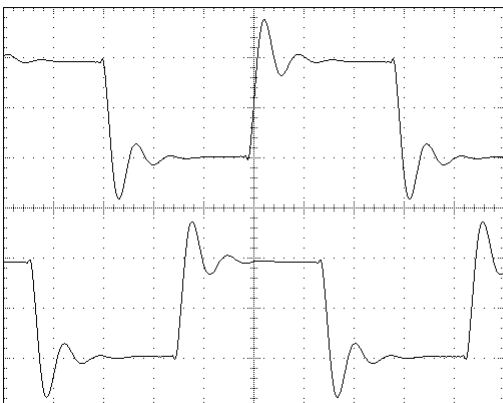

- Example of bad waveform: waveform is stepped



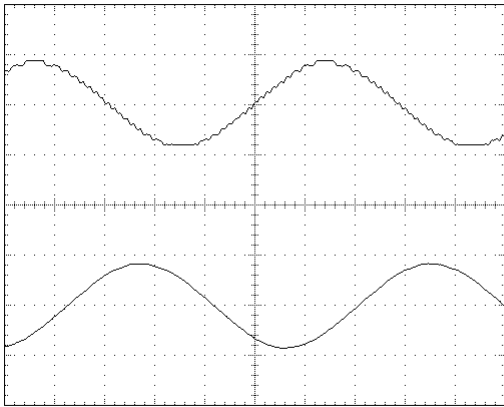

- Press the [▶] switch to proceed to the next step.

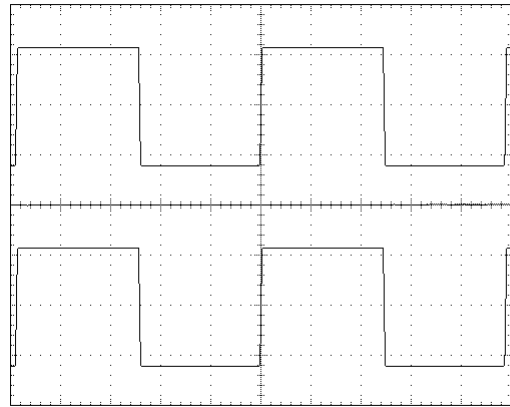

- Confirm that the LINE/PHONES waveform amplitude is between 290 and 410 (mVp-p).

## 10. INPUT A/D Check, AUX IN Check, Noise Check

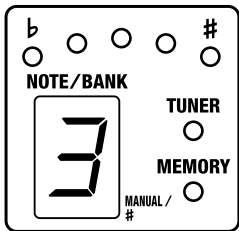

### (1) INPUT A/D Check

Input a rectangular wave to the INPUT jack only, then check the waveform from OUTPUT.

- INPUT Signal: 400-Hz, 50-mVp-p square wave
- Oscilloscope Settings: Ch1: 0.2 V/div; Ch2: 0.2 V/div; TIME: 0.5 ms/div
- Confirm that the value for the waveform amplitude is between 320 and 460 (mVp-p).

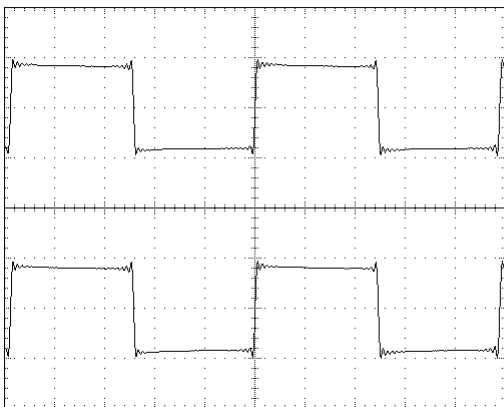

### (2) AUX IN Check

Input a rectangular wave to the AUX IN jack only, then check the waveform from OUTPUT.

- INPUT Signal: 400-Hz, 200-mVp-p square wave
- Oscilloscope Settings: Ch1: 0.2 V/div; Ch2: 0.2 V/div; TIME: 0.5 ms/div
- Confirm that the value for the waveform amplitude is between 400 and 560 (mVp-p) GUITAR/AMP Jack.

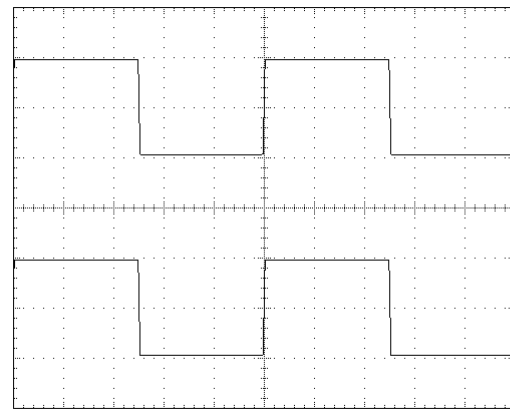

### (3) INPUT-to-OUTPUT Noise Check

- Disconnect cable connected to INPUT and AUX IN.
- Listen to the noise and confirm the following.
  1. Noise level is -83.0 dBm IHF-A (JIS-A) or lower (both L and R).
  2. No abnormal sounds are mixed with the output sound.
  3. No abnormal sounds occur when the unit is subjected to shock.
- Press the [▶] switch to proceed to the next step.

## 11. EXP Pedal Adjustment

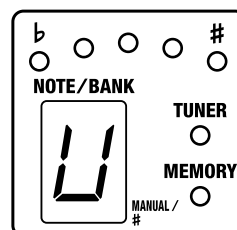
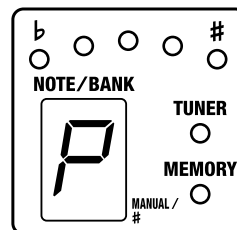

- Raise the unit's expression pedal completely, release the pedal, and press the [WRITE] switch.

## NOTE

Note: Release the pedal when the pedal is fully raised, then press the [WRITE] switch.

If an error occurs, the green LED in the upper portion of the seven-segment LED display flashes.

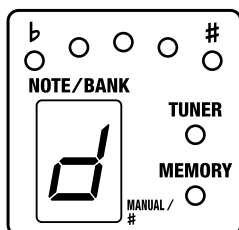

- Press the unit's expression pedal completely forward, release the pedal, and press the [WRITE] switch.

## NOTE

Note: Release the pedal when the pedal is pressed down completely, then press the [WRITE] switch.

If an error occurs, the green LED in the upper portion of the seven-segment LED display flashes.

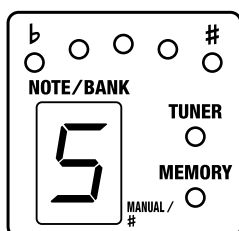

- Press the [◀] or [▶] switch to select "5," then press the [WRITE] switch.
- If no problem exists, the procedure automatically proceeds to Factory Reset.

## Factory Reset

"F" appears in the seven-segment LED.

- Press the [WRITE] switch. The BANK LED flashes.
- Press the [WRITE] switch. The seven-segment LED and BANK LED flash, and the factory data is loaded.

The dot in the seven-segment portion lights, and Factory Reset is completed when the unit switches to Play mode.

## NOTE

Never turn off the power while factory data is being loaded.

When the above is completed, the unit quits Test mode.

**BLOCK DIAGRAM**

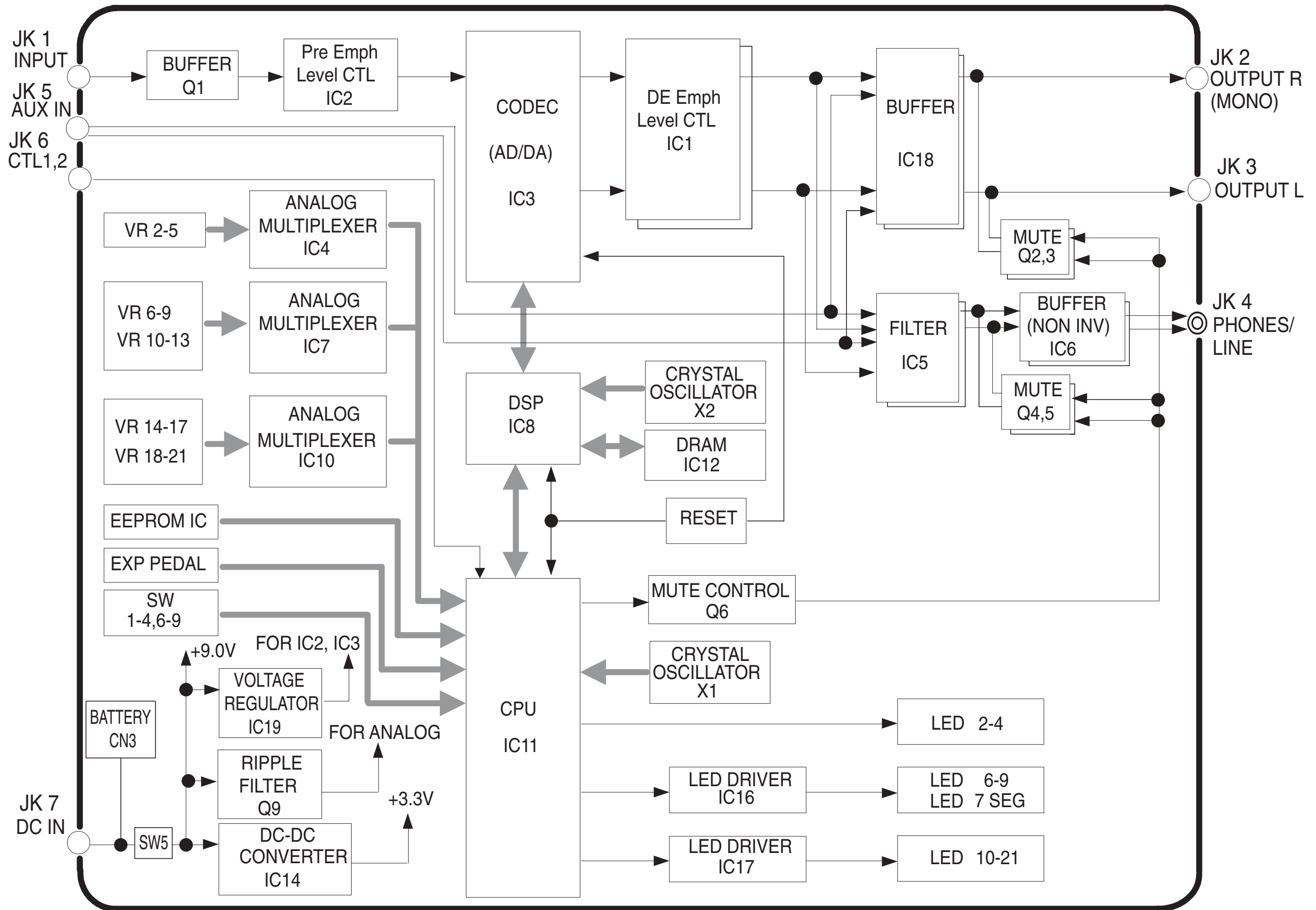

# CIRCUIT BOARD

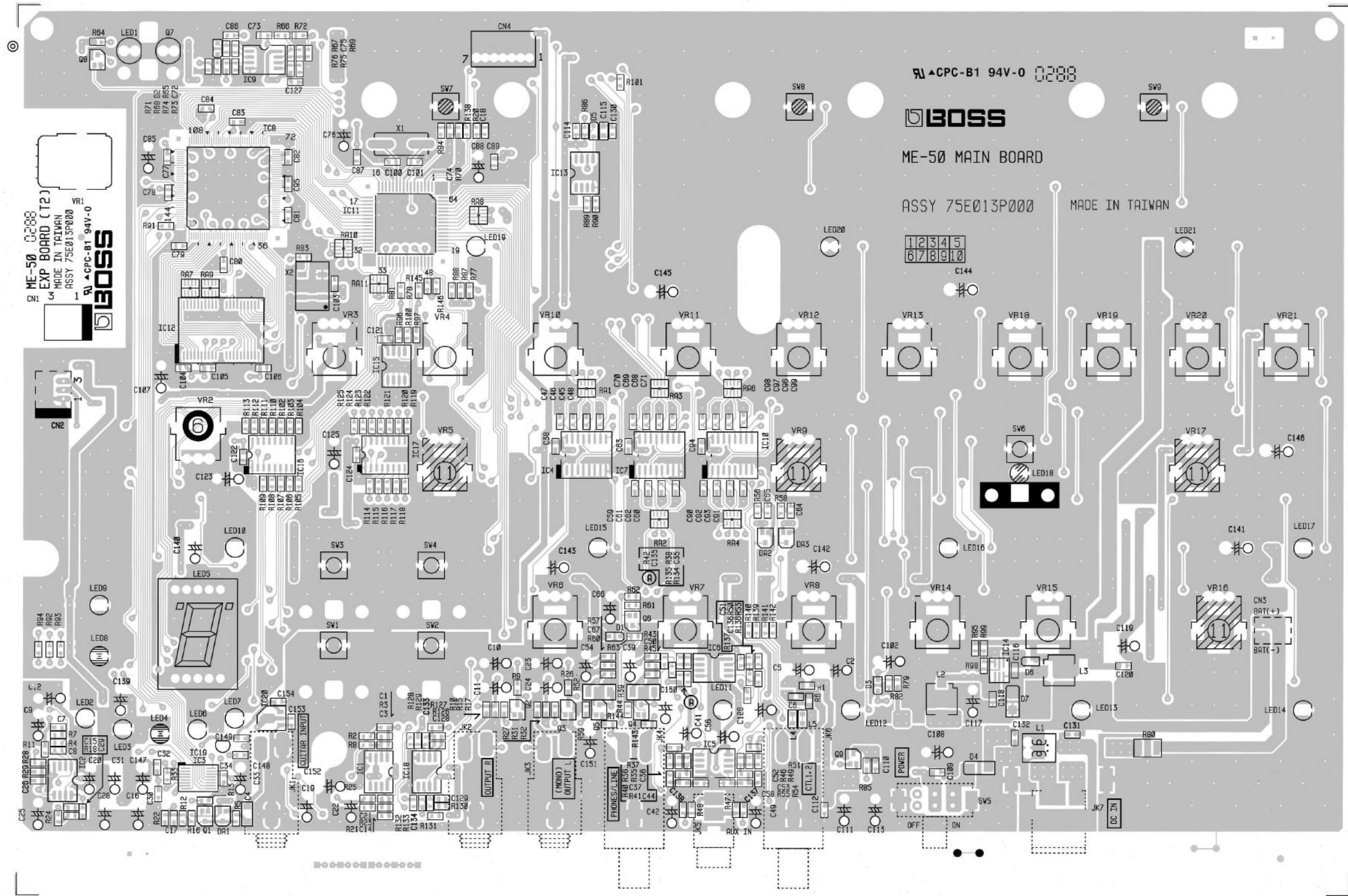

ME-50 0288  
EXP BOARD (T2)  
MADE IN TAIWAN  
ASSY 75E013P000  
VR1  
CPC-B1 94V-0  
BOSS

CPC-B1 94V-0 0288

BOSS

ME-50 MAIN BOARD

ASSY 75E013P000

MADE IN TAIWAN

1	2	3	4	5
6	7	8	9	10

View from components side

# CIRCUIT BOARD

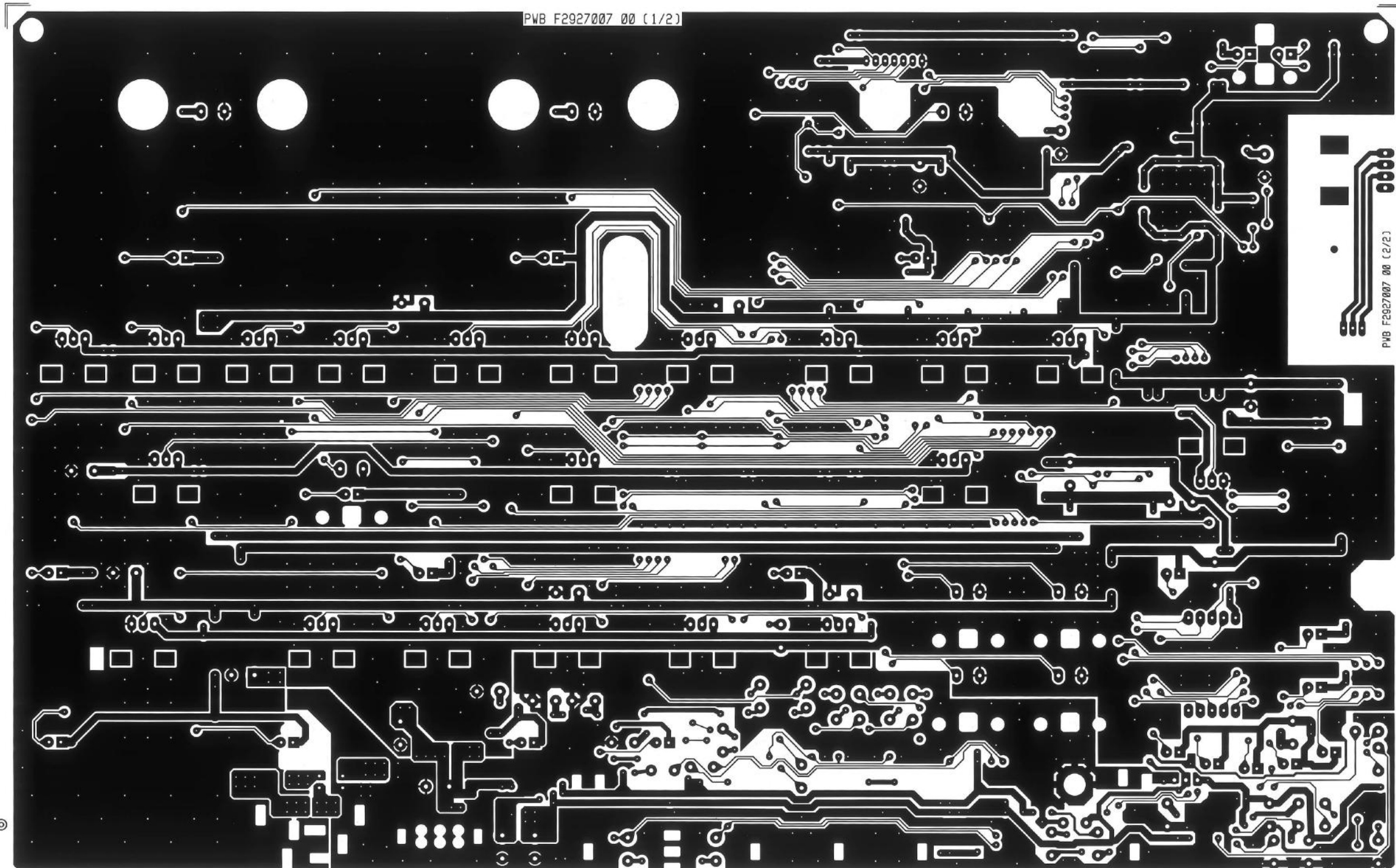

ME-50 MAIN SHEET PWB F2927007 00

View from foil side



