

Date	2-3-67	№ parte		Auto	
Disegnato		Controllato		Disegnato	
UP80/1					

Krunpaal
RADIO ELETTROMECCANICA
Parma - Italy

SCHEMA
UNITÀ DI POTENZA 1080

TU 100/6

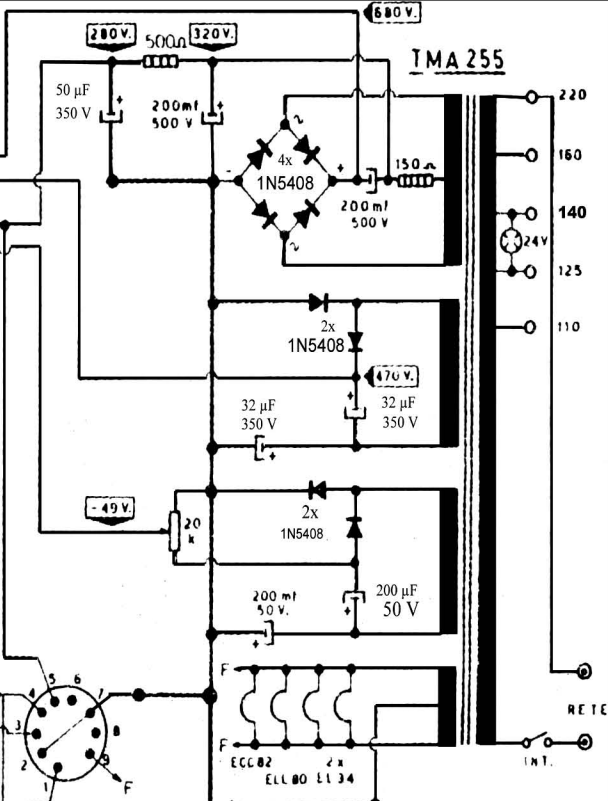
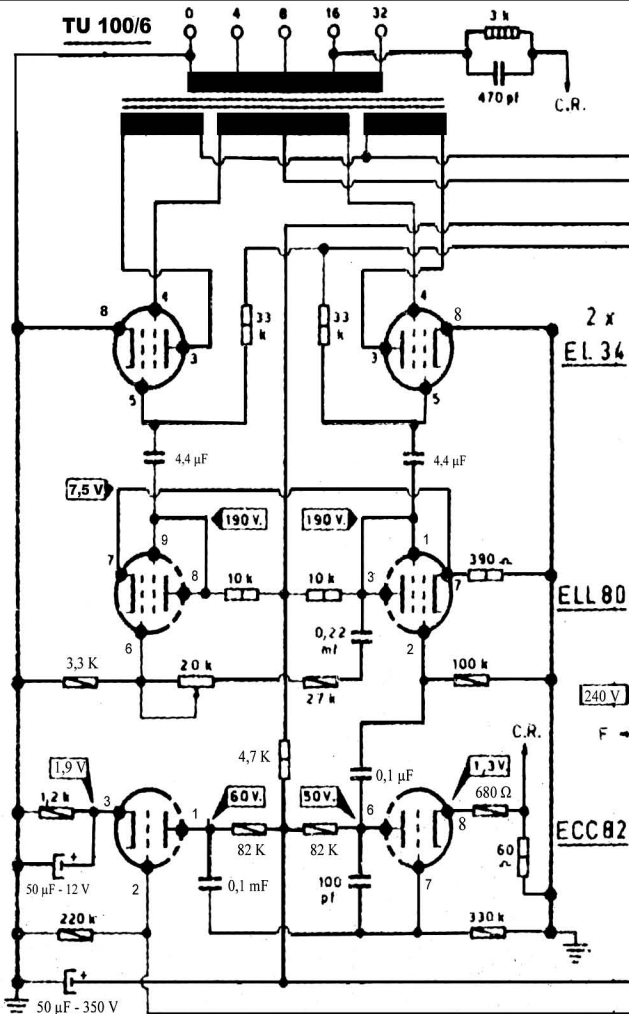

INGRESSO UNITA' DI POTENZA

TENSIONI MISURATE CON VOLTMETRO 20.000 Ω/V.

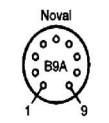

ECC82

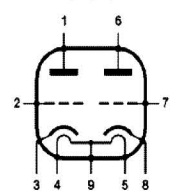

ELL80

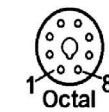
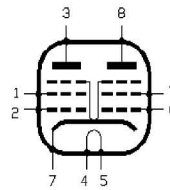

EL34

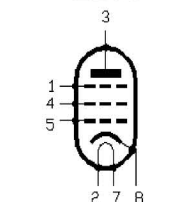

<p>Rundal RADIO ELETTROMECCANICA Parma - Italy</p>	<p>SCHEMA UNITÀ DI POTENZA 1080</p>
---	---