

Customer Name:		Gallien-Krueger		Current Rev #:		A1		New ECO Rev #:		A2	
Model:		Backline 250, 600, 115 Combo,		Distribute To:				Page:		1 Of: 2	
Assembly Description:		and 210 Combo		Originator:		Enrique Hernandez					
Assembly Numbers:		206-0181-A		Approved by:				Effective Date:		2/15/2005	
Effective				Document Update				Date		Initials	
<input checked="" type="checkbox"/>	All in Process	<input checked="" type="checkbox"/>	Next Buy	<input type="checkbox"/>	Artwork						
<input type="checkbox"/>	All in Service	<input checked="" type="checkbox"/>	Next Production Run	<input type="checkbox"/>	Assembly Dwg.						
<input checked="" type="checkbox"/>	All in Stock	<input type="checkbox"/>		<input type="checkbox"/>	Board Artwork						
Beginning Serial Number:				<input checked="" type="checkbox"/>	BOM						Noli
Reason For Change				<input type="checkbox"/>	Control Form						
Pre-Amp revoiced to sound more like the 400RB-IV.				<input checked="" type="checkbox"/>	Costing						TC
				<input type="checkbox"/>	Fab Drawing						
				<input type="checkbox"/>	Inspection Proc.						
				<input checked="" type="checkbox"/>	Part Master File						Noli
				<input checked="" type="checkbox"/>	Schematic						Noli
				<input type="checkbox"/>	Service Manual						
				<input type="checkbox"/>	Test Procedure						
				<input type="checkbox"/>							
				<input type="checkbox"/>							
				<input type="checkbox"/>							
				Other Affected Assemblies							
				209-0180-A, 303-0180-A,							
				303-1180-A, 303-2180-A							
<input type="checkbox"/>	Continued on ECO Supplement Page										
Description Of Change				Distribution				Date		Initials	
Revoicing of the pre-amp to sound more like the 400RB-IV. Replaced certain resistors mentioned below to change the structure of the output waveform.				<input type="checkbox"/>	Accounting						
				<input type="checkbox"/>	Assembly						
				<input type="checkbox"/>	Customer						
				<input checked="" type="checkbox"/>	Engineering						
				<input checked="" type="checkbox"/>	Incoming Q.C.						
				<input type="checkbox"/>	Planning						
				<input checked="" type="checkbox"/>	Production Eng.						
				<input checked="" type="checkbox"/>	Purchasing						
				<input type="checkbox"/>	Q.A.						
				<input type="checkbox"/>	Receiving						
				<input type="checkbox"/>	Service						
				<input type="checkbox"/>	Test						
				<input type="checkbox"/>	Vendor						
				<input type="checkbox"/>							
				<input type="checkbox"/>							
<input type="checkbox"/>	Continued on ECO Supplement Page			<input checked="" type="checkbox"/>	Drawing(s) attached						
Part Number		Description		Parts Added				Parts Deleted			
				Qty	Ref. Designator			Qty	Ref. Designator		
060-5622-0		1/8W, 5.62K						1	R48		
060-5622-0		1/8W, 5.62K						1	R51		

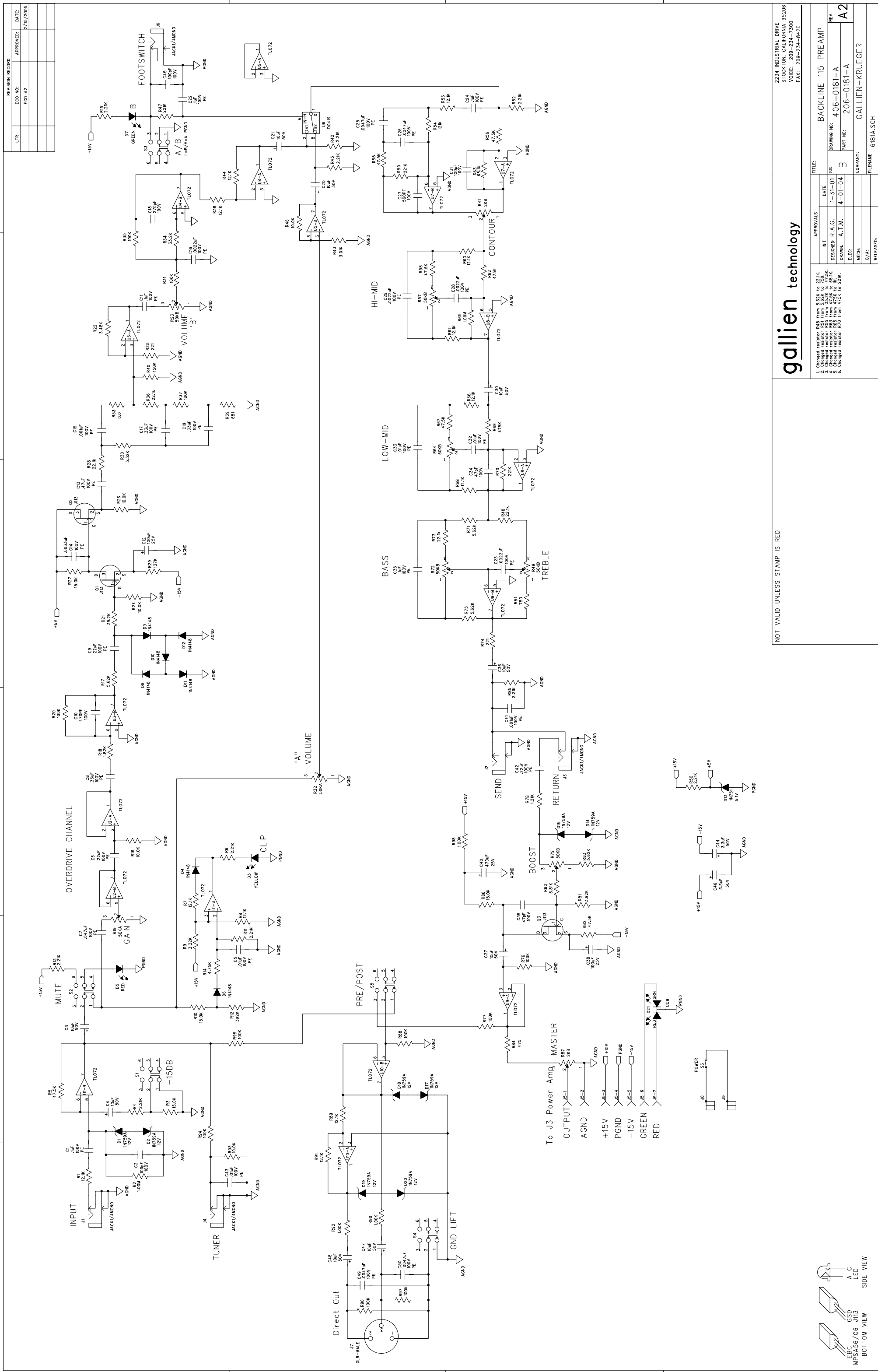

REVISION RECORD	
LTR	APPROVED: DATE:
ECO A2	2/15/2005

1 2 3 4 5 6

2234 INDUSTRIAL DRIVE  
STOCKTON, CALIFORNIA 95206  
VOICE: 209-234-7300  
FAX: 209-234-8420

**gallien technology**

TITLE: BACKLINE 115 PREAMP  
DRAWING NO: 406-0181-A  
REV: A2

APPROVALS  
INIT DATE  
DESIGNED: R.A.G. 1-31-01  
DRAWN: A.T.M. 4-01-04  
ELEC: MECH: COMPANY: GALLIEN-KRUEGER  
G/A: FILENAME: 6181A.SCH  
RELEASED:

1. Changed resistor R48 from 5.62K to 22K.  
2. Changed resistor R51 from 5.62K to 20K.  
3. Changed resistor R52 from 47.5K to 86K.  
4. Changed resistor R53 from 47.5K to 86K.  
5. Changed resistor R54 from 47.5K to 22K.  
6. Changed resistor R55 from 47.5K to 22K.

NOT VALID UNLESS STAMP IS RED

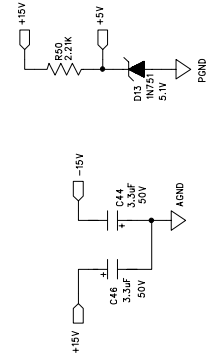
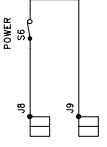
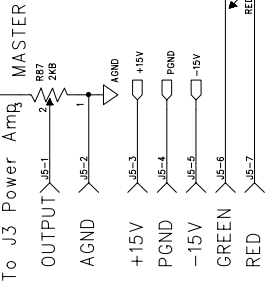
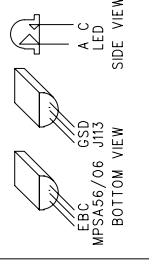

Customer Name:		Gallien-Krueger		Current Rev #:	A2	New ECO Rev #:	A3		
Model:		Backline 250, 600, 115 Combo, and 210 Combo		Distribute To:		Page:	1	Of:	2
Assembly Description:				Originator:	Enrique Hernandez				
Assembly Numbers:		206-0181-A		Approved by:					
				Effective Date:	3/11/2005				
Effective				Document Update		Date	Initials		
<input checked="" type="checkbox"/>	All in Process	<input checked="" type="checkbox"/>	Next Buy	<input type="checkbox"/>	Artwork				
<input type="checkbox"/>	All in Service	<input checked="" type="checkbox"/>	Next Production Run	<input type="checkbox"/>	Assembly Dwg.				
<input checked="" type="checkbox"/>	All in Stock	<input type="checkbox"/>		<input type="checkbox"/>	Board Artwork				
Beginning Serial Number:				<input checked="" type="checkbox"/>	BOM		Noli		
Reason For Change				<input type="checkbox"/>	Control Form				
Pre-Amp revoiced to sound more like the 400RB-IV.				<input checked="" type="checkbox"/>	Costing		TC		
				<input type="checkbox"/>	Fab Drawing				
				<input type="checkbox"/>	Inspection Proc.				
				<input checked="" type="checkbox"/>	Part Master File		Noli		
				<input checked="" type="checkbox"/>	Schematic		RAG		
				<input type="checkbox"/>	Service Manual				
				<input checked="" type="checkbox"/>	Test Procedure		ATM		
				<input type="checkbox"/>					
				<input type="checkbox"/>					
				Other Affected Assemblies					
				209-0180-A, 303-0180-A, 303-1180-A, 303-2180-A					
<input type="checkbox"/>	Continued on ECO Supplement Page								
Description Of Change				Distribution		Date	Initials		
Revoicing of the pre-amp to sound more like the 400RB-IV. Replaced certain resistors mentioned below to change the structure of the output waveform.				<input type="checkbox"/>	Accounting				
				<input type="checkbox"/>	Assembly				
				<input type="checkbox"/>	Customer				
				<input checked="" type="checkbox"/>	Engineering				
				<input checked="" type="checkbox"/>	Incoming Q.C.				
Add a 47.5K resistor as well to bass and treble circuit that is missing, and should be there, it is designated R99 on the schematic 206-0181-A3.				<input type="checkbox"/>	Planning				
				<input checked="" type="checkbox"/>	Production Eng.				
				<input checked="" type="checkbox"/>	Purchasing				
				<input type="checkbox"/>	Q.A.				
				<input type="checkbox"/>	Receiving				
				<input type="checkbox"/>	Service				
				<input type="checkbox"/>	Test				
				<input type="checkbox"/>	Vendor				
				<input type="checkbox"/>					
				<input type="checkbox"/>					
<input type="checkbox"/>	Continued on ECO Supplement Page			<input checked="" type="checkbox"/>	Drawing(s) attached				
Part Number	Description	Parts Added		Parts Deleted					
		Qty	Ref. Designator	Qty	Ref. Designator				
060-2213-0	1/8W, 22.1K			1	R48				
060-1752-0	1/8W, 47.5K			1	R55				

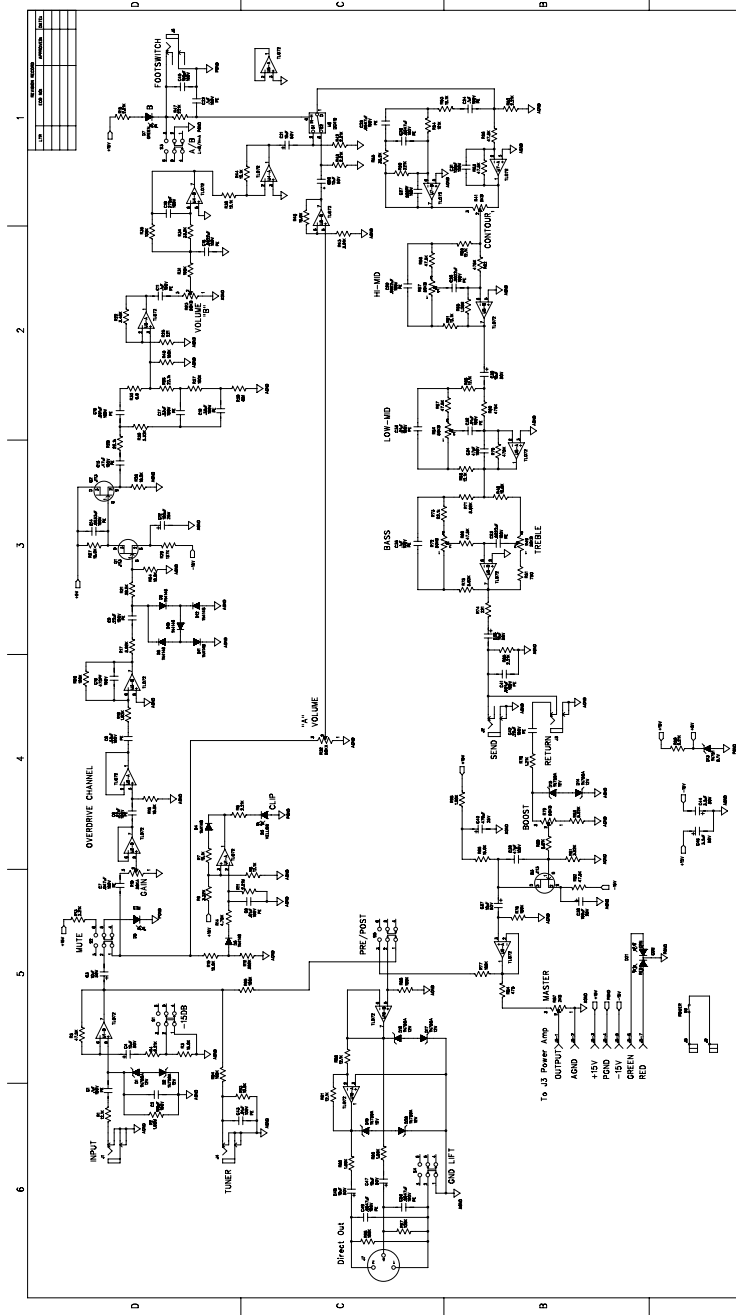

REF TAPED WALKER STAMP 8 RD

**galien technology**

NOTES: A. GALIEN TECHNOLOGY  
 B. GALIEN TECHNOLOGY  
 C. GALIEN TECHNOLOGY  
 D. GALIEN TECHNOLOGY

DATE: 01/01/01  
 DRAWN BY: J. GALIEN  
 CHECKED BY: J. GALIEN  
 PART NO.: 200-010-1.3  
 REV: 1.0  
 PROJECT: GALIEN-PROJECT

SEE FILE

Customer Name:		Gallien-Krueger		Current Rev #:		A3		New ECO Rev #:		A4	
Model:		Backline 250, 600, 115 Combo,		Distribute To:				Page:		1 Of: 2	
Assembly Description:		and 210 Combo		Originator:		Enrique Hernandez					
Assembly Numbers:		206-0181-A		Approved by:				Effective Date:		3/17/2005	
Effective				Document Update				Date		Initials	
<input type="checkbox"/>	All in Process	<input checked="" type="checkbox"/>	Next Buy	<input checked="" type="checkbox"/>	Artwork						RAG
<input type="checkbox"/>	All in Service	<input type="checkbox"/>	Next Production Run	<input type="checkbox"/>	Assembly Dwg.						
<input type="checkbox"/>	All in Stock	<input type="checkbox"/>		<input type="checkbox"/>	Board Artwork						
Beginning Serial Number:				<input checked="" type="checkbox"/>	BOM						Noli
Reason For Change				<input type="checkbox"/>	Control Form						
Renaming of two resistors on the pre-amp board to match layout counting scheme of the board.				<input checked="" type="checkbox"/>	Costing						TC
				<input type="checkbox"/>	Fab Drawing						
				<input type="checkbox"/>	Inspection Proc.						
				<input checked="" type="checkbox"/>	Part Master File						Noli
				<input checked="" type="checkbox"/>	Schematic						RAG
				<input type="checkbox"/>	Service Manual						
				<input type="checkbox"/>	Test Procedure						
				<input type="checkbox"/>							
				<input type="checkbox"/>							
				Other Affected Assemblies							
				209-0180-A, 303-0180-A,							
				303-1180-A, 303-2180-A							
<input type="checkbox"/>	Continued on ECO Supplement Page										
Description Of Change				Distribution				Date		Initials	
Update BOM.				<input type="checkbox"/>	Accounting						
Update Part Master File.				<input type="checkbox"/>	Assembly						
Updated Artwork 145-0181-A4.				<input checked="" type="checkbox"/>	Customer						
Resistor R98 changed to R87A, and resistor R99 changed to R74A.				<input checked="" type="checkbox"/>	Engineering						
				<input checked="" type="checkbox"/>	Incoming Q.C.						
				<input type="checkbox"/>	Planning						
				<input checked="" type="checkbox"/>	Production Eng.						
				<input checked="" type="checkbox"/>	Purchasing						
				<input type="checkbox"/>	Q.A.						
				<input type="checkbox"/>	Receiving						
				<input type="checkbox"/>	Service						
				<input type="checkbox"/>	Test						
				<input type="checkbox"/>	Vendor						
				<input type="checkbox"/>							
				<input type="checkbox"/>							
				<input checked="" type="checkbox"/>	Drawing(s) attached						
Part Number		Description		Parts Added				Parts Deleted			
				Qty	Ref. Designator			Qty	Ref. Designator		



Customer Name:		Gallien-Krueger		Current Rev #:		A4		New ECO Rev #:		A5	
Model:		Backline 250, 600, 115 Combo, and 210 Combo		Distribute To:				Page:		1 Of: 2	
Assembly Description:		preamp board		Originator:		Enrique Hernandez					
Assembly Numbers:		206-0181-A		Approved by:							
				Effective Date:		12/15/2005					
Effective				Document Update				Date		Initials	
<input checked="" type="checkbox"/>	All in Process	<input checked="" type="checkbox"/>	Next Buy	<input type="checkbox"/>	Artwork						
<input checked="" type="checkbox"/>	All in Service	<input checked="" type="checkbox"/>	Next Production Run	<input type="checkbox"/>	Assembly Dwg.						
<input type="checkbox"/>	All in Stock	<input type="checkbox"/>		<input type="checkbox"/>	Board Artwork						
Beginning Serial Number:				<input checked="" type="checkbox"/>	BOM						Noli
Reason For Change				<input type="checkbox"/>	Control Form						
DI output too hot, need to decrease DI level to match the level of the 700RB-II/1001RB-II pre-amp when level knob is set to max.				<input checked="" type="checkbox"/>	Costing						TC
				<input type="checkbox"/>	Fab Drawing						
				<input type="checkbox"/>	Inspection Proc.						
				<input checked="" type="checkbox"/>	Part Master File						Noli
				<input checked="" type="checkbox"/>	Schematic						Enrique
				<input type="checkbox"/>	Service Manual						
				<input type="checkbox"/>	Test Procedure						
				<input type="checkbox"/>							
				<input type="checkbox"/>							
				Other Affected Assemblies							
				209-0180-A, 303-0180-A, 303-1180-A, 303-2180-A							
<input type="checkbox"/>	Continued on ECO Supplement Page										
Description Of Change				Distribution				Date		Initials	
Update BOM.				<input type="checkbox"/>	Accounting						
				<input type="checkbox"/>	Assembly						
Update Part Master File.				<input type="checkbox"/>	Customer						
				<input checked="" type="checkbox"/>	Engineering						
				<input checked="" type="checkbox"/>	Incoming Q.C.						
				<input type="checkbox"/>	Planning						
				<input checked="" type="checkbox"/>	Production Eng.						
				<input type="checkbox"/>	Purchasing						
				<input type="checkbox"/>	Q.A.						
				<input type="checkbox"/>	Receiving						
				<input type="checkbox"/>	Service						
				<input type="checkbox"/>	Test						
				<input type="checkbox"/>	Vendor						
				<input type="checkbox"/>							
				<input type="checkbox"/>							
				<input type="checkbox"/>							
				<input type="checkbox"/>	Drawing(s) attached						
Part Number		Description		Parts Added				Parts Deleted			
				Qty	Ref. Designator			Qty	Ref. Designator		
206-1001-A		1001 1/01 Rev 1						1	206		







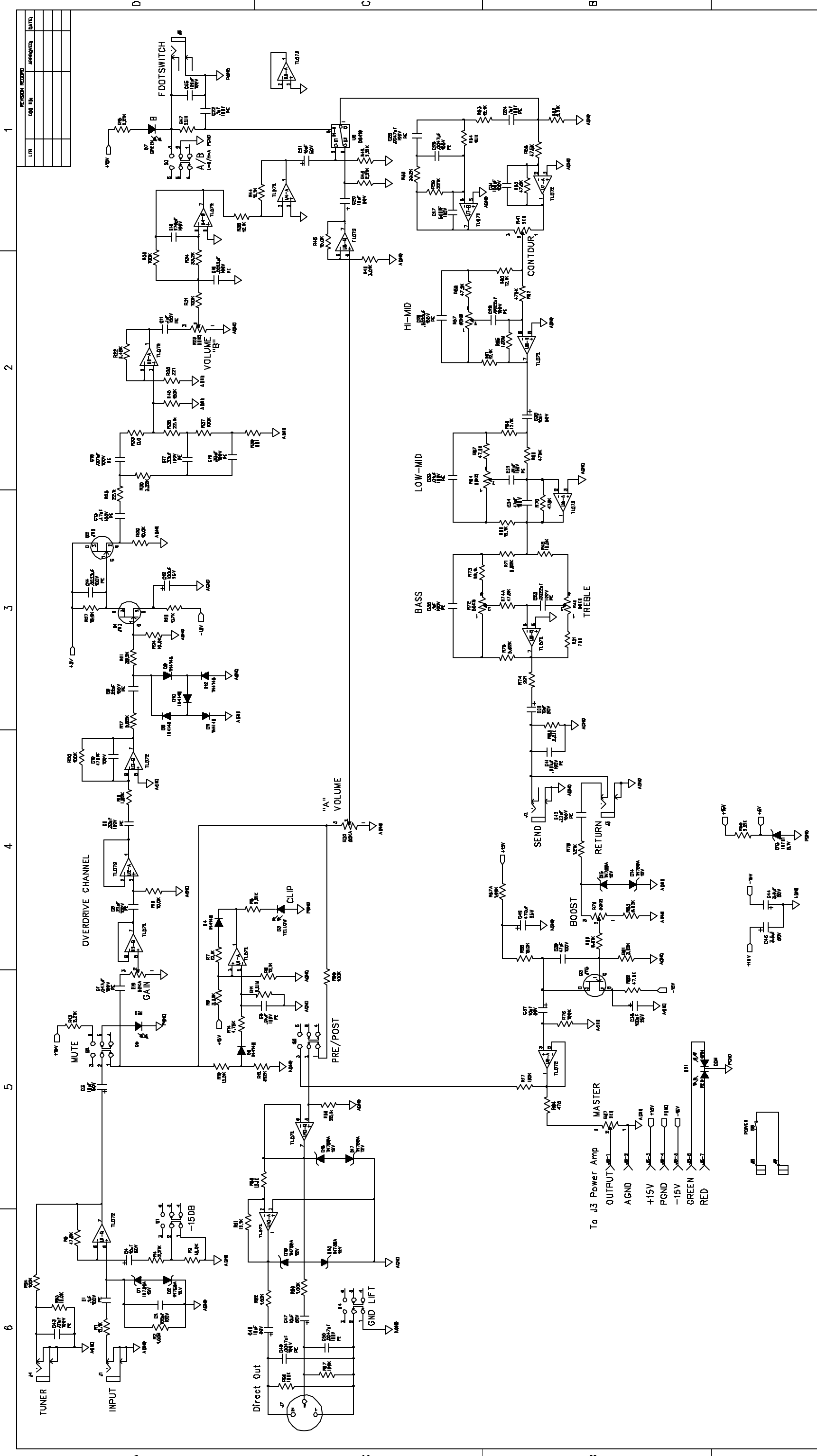

1  
2  
3  
4  
5  
6

REVISION RECORD

REV	DATE	DESCRIPTION

NOTES A6:  
1. MOVE R80 TO TOP OF R32.

gallien technology

2524 INDUSTRIAL DRIVE  
STOCKTON, CA 95208  
PHONE: 209-234-7300  
FAX: 209-234-8420

NOT VALID UNLESS STAMP IS RED

APPROVALS		TITLE	
DESIGNED: P.A.G.	DATE: 1-31-01	BACKLINE 115	PREAMP
DRAWN: R.A.C.	DATE: 7/7/08	DRAWING NO:	406-0181-A6
CHECKED:		PART NO:	A6
DATE:		COMPANY:	GALLIEN-KRUEGER
BY:		REVISION:	
DATE:		RELEASED:	
BY:		PREPARED:	6181A6.SCH

POWER: 15V  
GND  
EBC  
MPS36/08 JMS  
BOTTOM VIEW

A C LED  
SIDE VIEW