



**ENFORCER**  
**OPERATOR'S MANUAL**

19350 SW 89th Avenue

TUALATIN, OREGON 97062

**A HARTZELL CORPORATION COMPANY**

## TABLE OF CONTENTS

1. OVERVIEW
  - 1-1. INTRODUCTION
  - 1-2. FEATURES
  - 1-3. BLOCK DIAGRAM
  - 1-4. CIRCUIT DESCRIPTION
  - 1-5. SPECIFICATIONS
2. FRONT PANEL JACKS, CONTROLS and LEDs
  - 2-1. HI and LO GAIN INPUTS
  - 2-2. CHANNEL A CONTROLS
    - 2-2-1. DRIVE CONTROL
    - 2-2-2. BASS, MID and TREBLE CONTROLS
    - 2-2-3. LEVEL CONTROL
  - 2-3. CHANNEL B CONTROLS
    - 2-3-1. DRIVE CONTROL
    - 2-3-2. BASS, MID and TREBLE CONTROLS
    - 2-3-3. LEVEL CONTROL
  - 2-4. REVERB LEVEL CONTROL
  - 2-5. PRESENCE LEVEL CONTROL
  - 2-6. "CHANNEL ON" INDICATOR LEDs
  - 2-7. 60 WATT/100 WATT OUTPUT POWER LEVEL SWITCH
  - 2-8. STANDBY SWITCH
  - 2-9. MAINS (ON/OFF) SWITCH
3. BACK PANEL JACKS, FUSE and POLARITY SWITCH
  - 3-1. A/B FOOTSWITCH JACK
  - 3-2. EFFECTS SEND
  - 3-3. EFFECTS RETURN
  - 3-4. REVERB FOOTSWITCH JACK
  - 3-5. LINE OUT
  - 3-6. SPEAKER OUTPUTS
  - 3-7. FUSE
  - 3-8. POLARITY SWITCH
4. A/B CHANNEL SELECT FOOTSWITCH
5. PATCHING
6. A FEW WORDS ABOUT TUBES
  - 6-1. REPLACING TUBES
    - 6-1-1. PREAMP TUBES
    - 6-1-2. OUTPUT TUBES
  - 6-2. WHAT IS THE "TUBE SOUND"?
7. OPERATING HINTS AND SAMPLE SETTINGS
8. UPKEEP AND SERVICE
9. WARRANTY

## 1. OVERVIEW

1-1. INTRODUCTION. Ever since Fleming discovered that the light bulb could be modified to control the flow of electrical current, engineers have explored the myriad capabilities of the vacuum tube. In audio applications this reached a crescendo in the late 1950's and early 1960's. With the advent of solid state circuitry, many believed that the transistor would put an end to the vacuum tube's long career. And yet, in the 1980's, the vacuum tube is alive and well, especially among guitarists who value the warmth of tone, the quality of distortion and the dynamic characteristics which make it particularly well-suited to musical expression. Recognizing these unique qualities, SUNN has created circuitry which best takes advantage of this uniqueness and proudly introduces the ENFORCER guitar amplifier.

The ENFORCER is a ruggedly built two-channel 100 watt instrument amplifier designed for ease of use and maximum versatility. This versatility is apparent in the differing design approach taken for each of the two channels. In Channel A the equalization (tone controls) is located prior to the portion of the circuit that saturates, or musically distorts, while Channel B employs post-distortion EQ. There are other differences as well, but the end result is that each channel treats signals in a different way, giving each its own distinctive personality. The player can choose at any moment which sound he prefers, since either channel may be selected individually by footswitch. As a bonus, both may be selected at the same time and mixed together in any proportion to obtain entirely new voicings, never before available.

Preamp Drive and Master Level controls on each channel permit independent control of overdrive and volume. A Presence control and the amp's reverb system are common to both channels. In the event that the full 100 watt output of the amplifier is not needed, a switch turns two of the output tubes off, lowering the power to 60 watts. A line level patch loop is also provided for the insertion of effects devices in the signal path, and a Line Out jack allows the entire sound of the ENFORCER to be patched to a mixing console or auxiliary power amplifier. Remote channel selection is accomplished by footswitch, and the reverb may also be selected remotely.

Because of the wide variety of sounds a guitarist must be capable of producing, he needs an amplifier that will rise to any occasion, being responsive, versatile, easy to adjust and able to withstand the rigors of the road and stage. We believe that the ENFORCER is such an amp, and we are sure that you will too.

## 1-2. FEATURES.

- \* High and low gain inputs to accommodate a wide variety of instruments
- \* Two footswitch-selectable channels (A,B or both)
- \* Lighted channel status indicators
- \* Footswitch for remote channel selection with indicator LEDs
- \* All-tube preamps and power amplifier
- \* Independent Drive (Preamp Level), EQ and Master Level controls on each channel
- \* Pre-distortion EQ on Channel A, post-distortion EQ on Channel B
- \* Reverb with level control, common to both channels
- \* Presence control common to both channels
- \* Switch-selectable output power (60 watt/100 watt)
- \* Standby switch
- \* Polarity switch
- \* True line-level effects patching via Effects Send and Effects Return jacks
- \* Reverb footswitch jack permits remote selection of reverb
- \* Line Out jack provides a line level signal from the output of the power amplifier which may be used to drive an auxiliary power amplifier or as a direct send to a mixing console
- \* Dual speaker output jacks (4 ohm/8 ohm at 100 watts or 8 ohm/16 ohm at 60 watts) allow proper matching between the speaker load and the power amplifier, maximizing available power
- \* Polarity switch to minimize AC hum

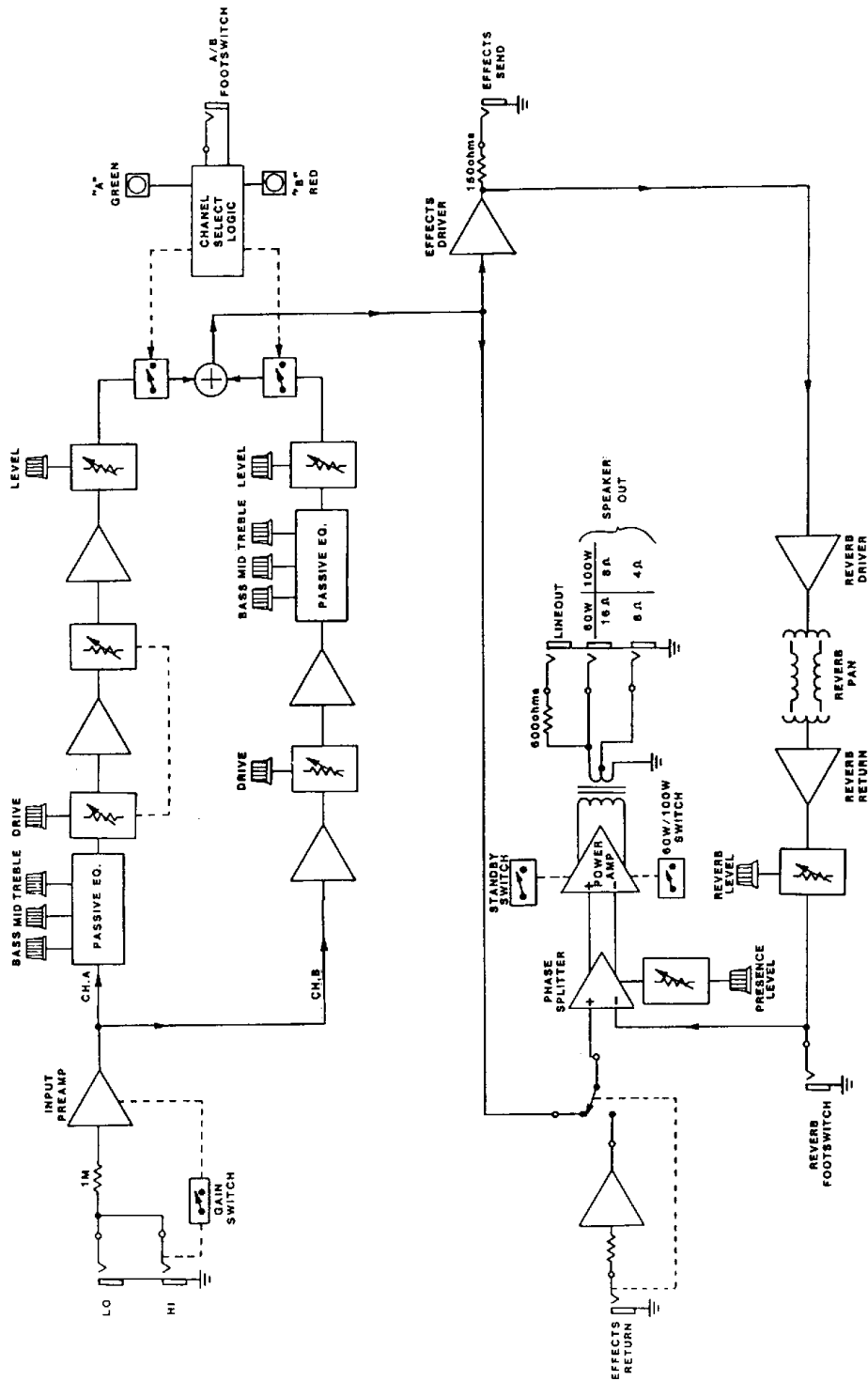

**ENFORCER  
BLOCK DIAGRAM**

8/82 1/22/84

1-4. CIRCUIT DESCRIPTION. A guitar signal enters the Enforcer through either the HI or LO gain input jack and passes on to the first preamp stage which is common to both channels. From here the signal path forks, passing to the individual circuits associated with Channels A and B. The signal to Channel A goes first through a three-band (Bass, Mid, Treble) passive EQ and from there to the first half of a dual DRIVE control. This control simultaneously adjusts the gain of the following two preamp stages. At the low gain end of the control's adjustment the gain of both stages is reduced, making it easy to obtain clean (undistorted) response from the preamp; turning the knob clockwise increases the gain of both stages, causing them to be overdriven and adding extra "bite" and sustain to the signal. From the output of the Channel A dual gain stage the signal passes through the Channel A LEVEL control to the electronic channel select switch where it joins the Channel B signal path and heads on to the power amp circuitry.

Meanwhile, the input preamp signal is also passing through the Channel B circuitry, where it first encounters a preamp stage which boosts the signal to near-saturation levels. Following this is the Channel B DRIVE control, another preamp stage and the Channel B tone controls. Placement of these controls after all of the stages of preamplification marks the main difference between Channels A and B. The Channel B preamp also utilizes a somewhat different output circuit, called a "cathode follower," which produces an overdriven sound of a slightly different character. It is the cathode follower that drives the Channel B tone controls. From the tone controls the signal passes through the Channel B LEVEL control and the electronic channel select switch, where it merges with the Channel A signal path and continues on to the power amp circuitry.

The footswitch-operated channel select logic determines whether the signal amplified by the Enforcer's power amplifier comes from Channel A, Channel B or from both channels at the same time. When both channels are selected the level of each channel in the final mix is determined by the settings of the DRIVE and LEVEL controls on each channel.

The point at which the Channel A and Channel B signal paths merge is also a cross-roads of sorts. Here, the signal is routed both to the effects driver and to the power amplifier. The effects driver buffers the signal and sends it to the EFFECTS SEND jack and to the internal reverb system. When nothing is patched into the EFFECTS RETURN jack, the power amplifier receives its entire signal from the "cross-roads" (the Channel A/Channel B junction) and from the reverb system. However, when an external effect is patched between the EFFECTS SEND and EFFECTS RETURN jacks, the normal signal path is broken and the power amplifier receives its signal from the EFFECTS RETURN jack and from the reverb system.

The power amplifier itself consists of a phase splitter which drives four output tubes (6L6GC's) operating in push-pull, with an output transformer coupling the 6L6GC's to the loudspeakers. Two of the output tubes may be disabled via the OUTPUT POWER LEVEL switch when lower power is desired. This reduces the available output power from 100 watts to 60 watts. A line level version of the full output of the amplifier is available at the LINE OUT jack, which is useful for patching the Enforcer to the main mixing console in a PA system or recording studio, or to an auxiliary amplifier and speaker when more power is needed. (The EFFECTS SEND may be used in the same manner if only the pre-reverb, pre-power amp sound is desired.)

The PRESENCE control shapes the frequency response of the power amplifier and thus affects both channels equally. The REVERB control is also common to both channels.

1-5. SPECIFICATIONS	
NUMBER OF CHANNELS:	2
INPUT SENSITIVITY:	
HI GAIN INPUT:	500 microvolts RMS at 1 kHz
LO GAIN INPUT:	2 millivolts RMS at 1 kHz
EFFECTS RETURN:	1.8 V RMS
INPUT IMPEDANCE:	
HI GAIN INPUT:	1 megohm
LO GAIN INPUT:	1 megohm
EFFECTS RETURN:	10 K ohms
PREAMP OUTPUT IMPEDANCE:	150 ohms
RECOMMENDED SPEAKER LOAD IMPEDANCE:	
AT 60 WATTS:	8 ohms or 16 ohms (using designated jack)
AT 100 WATTS:	4 ohms or 8 ohms (using designated jack)
MAXIMUM GAIN AVAILABLE:	106 dB
PASSIVE EQUALIZATION:	CHANNEL A BASS, MID, TREBLE CHANNEL B BASS, MID, TREBLE
ACTIVE EQUALIZATION:	PRESENCE (common to both channels)
OUTPUT POWER:	60 or 100 W RMS, switch-selectable
WEIGHT:	AMP TOP ONLY                      SELF-CONTAINED 58 Lbs., 26.4 kg.                  91 Lbs., 41.4 kg.
DIMENSIONS:	
AMP TOP ONLY:	Height x Depth x Width 10.5" x 9.5" x 26.3" 26.7cm. x 24.1cm. x 66.8 cm.
SELF-CONTAINED:	20.4" x 9.5" x 26.3 " 51.7cm. x 24.1cm. x 66.8cm.
SPEAKER:	2 SUNN MODEL 118 12 inch, 8 ohms, 100 watts
AC REQUIREMENTS:	Domestic                              Export 120 VAC, 60 Hz,                      240 VAC, 50/60 Hz, 2.5 A., 300 watts                      1.25 A., 300 watts

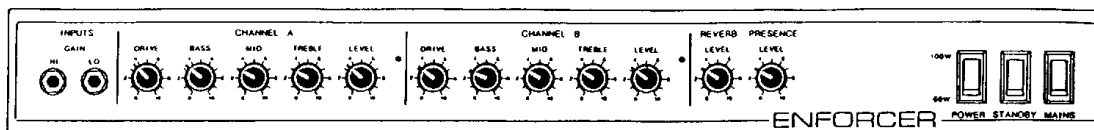

FIGURE 2

2. FRONT PANEL JACKS, CONTROLS and LEDs.

2-1. HI and LO GAIN INPUTS. To accommodate a wide variety of guitars, the Enforcer has been provided with two 1/4" phone input jacks-- a LO and a HI GAIN INPUT. The HI GAIN INPUT provides 6 dB more gain than the LO GAIN INPUT. The higher gain causes the tubes to go into saturation (musical distortion) at lower input levels; thus you should use the HI GAIN INPUT with guitars having low output levels or with any guitar if you like lots of distortion and sustain. Otherwise, use the LO GAIN INPUT.

## 2-2. CHANNEL A CONTROLS.

2-2-1. DRIVE CONTROL. The Channel A DRIVE control is located in the circuit prior to the preamp stages where distortion takes place. It is a dual control and adjusts the gain of two stages at once, making it easy to vary the channel's sound from very clean to heavily distorted. The more the DRIVE control is turned up, the more the Channel A preamp tubes are overdriven, causing them to distort the signal. This distortion harmonically enriches the signal and increases the sustain of the note. The DRIVE control is used in combination with the Channel A LEVEL control to obtain the desired degree of overdrive at any volume. To play clean and loud through Channel A, keep the Channel A DRIVE control low and turn up the CHANNEL A LEVEL control. For a distorted sound, turn up the Channel A DRIVE control and adjust the volume with the Channel A LEVEL control. More tips and sample settings will be given in Section 7.

2-2-2. BASS, MID and TREBLE CONTROLS. The Channel A BASS, MID and TREBLE controls use passive circuitry for low noise and easy adjustment. Their particular design makes them interactive (for example, turning up the TREBLE control reduces the bass, and turning up the BASS control changes the center frequencies of the MID and TREBLE controls), increasing their versatility. These controls are located in the circuit prior to the high gain preamp stages where distortion occurs (this is referred to as pre-distortion EQ). The BASS control primarily affects frequencies below 250 Hz, the MID control affects frequencies from about 200 Hz to 2 kHz and the TREBLE control primarily affects signals in the range of 1 kHz to 20 kHz.

2-2-3. LEVEL CONTROL. The Channel A LEVEL control functions as a master volume control for that channel. Generally, the sound of a channel is not affected significantly by changing the setting of the LEVEL control; however, the power amplifier section of the Enforcer is also capable of being driven into distortion (many players like the sound of vacuum tube power amp distortion), and the degree of this distortion is determined by how hard it is driven. Therefore, at higher volumes, the sound of the amplifier may change. This is not a drawback, but an inherent property of tubes, and yet another way of obtaining different sounds.

## 2-3. CHANNEL B CONTROLS.

2-3-1. DRIVE CONTROL. The Channel B DRIVE control determines the gain of the Channel B preamp. It is used in conjunction with the Channel B LEVEL control to determine the overall volume of that channel.

2-3-2. BASS, MID and TREBLE CONTROLS. The Channel B EQ (BASS, MID and TREBLE) controls are passive as in Channel A (see Section 2-2-2). However, they are located after the high gain Channel B preamp stages where distortion occurs. This arrangement is known as "post-distortion EQ." The difference between the sounds of pre- and post-distortion EQ is difficult to describe, but it is obvious to the ear. Each type of sound has its place, and you may find you prefer one sound for one song, and the other sound for a different song. Take some time to get to know the distinctive qualities of the two channels.

2-3-3. LEVEL CONTROL. The Channel B LEVEL control is the master volume control for that channel, and operates in the same way as the Channel A LEVEL control (see Section 2-2-3).

2-4. REVERB LEVEL CONTROL. This control determines how much reverb is added to the "dry" guitar signal. The REVERB LEVEL control is common to both channels.

2-5. PRESENCE LEVEL CONTROL. Turning up the PRESENCE control brightens the sound of the amplifier, increasing its gain at frequencies above 2 kHz. It is common to both channels.

2-6. "CHANNEL ON" INDICATOR LEDs. Whenever the green CHANNEL A LED (Light Emitting Diode) is on, the CHANNEL A preamp circuitry and its associated controls (DRIVE, BASS, MID, TREBLE and LEVEL controls) are active, and when the red CHANNEL B LED is lit, the corresponding Channel B circuitry and controls are active. The footswitch selects which LEDs, and hence which channels, are on at any given time. If the footswitch is not plugged in, both channels and both LEDs are active.

2-7. 60 WATT/100 WATT OUTPUT POWER LEVEL SWITCH. With the switch in the 100 WATT position (lighted) all four output tubes are active, and the Enforcer is a 100 watt amplifier. With the switch in the 60 WATT position (unlighted) two of the output tubes are disabled, turning the Enforcer into a 60 watt amplifier. The filaments of the two tubes that have been disabled remain energized, making it unnecessary to wait for them to warm up when you switch back to the 100 watt mode.

Note: The output impedance of the amplifier doubles when it is put into the 60 watt mode. Thus, the 4 ohm output jack becomes an 8 ohm output and the 8 ohm jack becomes a 16 ohm output. This is indicated above the jacks on the back panel of the Enforcer. For best results, use the correct jack for the power level chosen and for the speaker(s) being used.

2-8. STANDBY SWITCH. Turning the STANDBY switch to its "off" (unlighted) position removes the high voltage from the output tubes, while keeping their filaments energized. This allows the Enforcer to be silenced during breaks in a performance without having to wait for the amp to warm up again after the break is over.

NOTE: The STANDBY switch does not disable the preamp tubes. If you use the EFFECTS SEND jack to drive a mixing console or an auxiliary amplifier, you will find that it is still active even though the amplifier is on standby. If this is a problem, use the LINE OUT jack instead.

2-9. MAINS (ON/OFF) SWITCH. The MAINS (ON/OFF) switch controls the Enforcer's AC power. Because the vacuum tubes have to warm up, it takes 30 to 60 seconds from the time the switch is first turned on to the time the amplifier is ready for use.

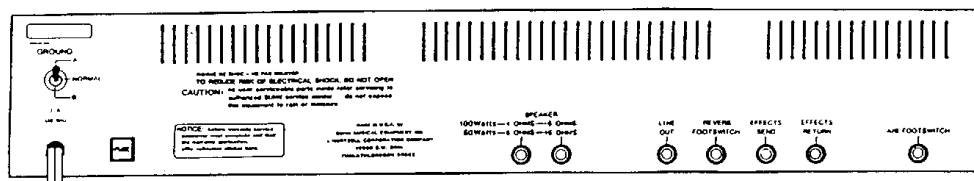

FIGURE 3

### 3. BACK PANEL JACKS, FUSE and POLARITY SWITCH.

3-1. A/B FOOTSWITCH JACK. With the footswitch plugged into this jack, Channel A, Channel B or both may be selected. With the footswitch unplugged, both channels are automatically selected.

3-2. EFFECTS SEND. An unbalanced line level preamp output signal is available from this jack. The primary use for this jack is to drive the input of an external effect (phase shifter, equalizer, digital delay, etc.), with the EFFECTS RETURN jack used as the return point for the signal from the effect. In addition, the EFFECTS SEND jack may be used as a direct send to the mixing console of the main PA system or recording setup, or it can serve as an output to drive an auxiliary power amplifier when more power is needed. These latter uses, however, are better served by the LINE OUT jack (see Section 3-5).

For patching examples, see Section 5.



3-3. EFFECTS RETURN. Inserting a 1/4" plug into this jack interrupts the normal signal flow, and only signals carried by the plug pass on to the power amplifier. This allows an external signal processing device, such as an equalizer, compressor, digital delay or phase shifter, to be patched between the EFFECTS SEND jack and the EFFECTS RETURN jack. For an illustration of this, see Section 5.

3-4. REVERB FOOTSWITCH JACK. This jack allows the reverb in the Enforcer to be switched on and off from a remote location. Any standard reverb footswitch may be used in this application. If you do not have such a footswitch, one can be created by connecting one end of an unbalanced shielded cable to a 1/4" phone plug and the other end to a single-pole single-throw (SPST) push-on/push-off pushbutton switch. On the "plug end" of the cable, the center conductor goes to the tip of the plug and the shield goes to the shell of the plug; on the "switch end," the center conductor connects to one of the switch terminals and the shield connects to the other. Closing the switch turns off the reverb.

3-5. LINE OUT. Any signal present at the speaker outputs is also available as a line level output (0 to 10 VRMS, depending upon the Enforcer's output volume) from the LINE OUT jack. This may be used as a direct send to the mixing console of the main PA system or recording studio, and may also be used to drive auxiliary power amplifiers when more power is needed (see Section 5 for sample patches).

3-6. SPEAKER OUTPUTS. Connect your loudspeaker(s) to the Enforcer via these jacks, using 16 gauge or heavier zip cord. The combined impedance of your speakers should match that indicated above the jack. Because the Enforcer uses an output transformer, it is able to match the load and provide maximum output, provided the proper jack is used. The legend above the jacks indicates the proper impedance for each jack at the power level selected (see Section 2-7).

CAUTION: DO NOT operate the Enforcer without a load, as this may result in damage to the amplifier.

NOTE: Guitar cords were not designed to handle much power, and should not be used as speaker cords.

3-7. FUSE. This is the Enforcer's AC power fuse. If it blows, remove it by pushing a small screwdriver gently into the slot located at the top of the fuse holder. The cap of the fuse holder should release and pop partially out, bringing the fuse with it. Remove the fuse and replace it with another fuse of the same type and rating. If the fuse blows repeatedly, verify that the speaker is connected to the proper jack (see Section 3-6), and that the speaker cord is not shorted. Check the tubes, either by substituting ones that are known to be good for the ones in the amplifier or, preferably, by using a tube tester (many electronic supply stores have these, as do some pharmacies and variety stores). Except for the tubes, there are no user-serviceable parts in the Enforcer; therefore, if there is a problem with the amplifier, it should be referred to qualified service personnel.

3-8. POLARITY SWITCH. The power cord supplied with the Enforcer employs a standard 3-prong plug with an AC safety ground attached to the Enforcer's chassis. Use of this safety ground is generally sufficient to minimize hum in the amplifier, and the POLARITY switch should be in its center, or NORMAL, position. Unfortunately, many older buildings (taverns, night clubs and theaters) are wired with two-prong outlets, without the safety ground, and in some buildings (even newer ones) the outlets are mis-wired. In such cases the chassis may be "floating" with respect to the AC line, which could result in excessive hum being present in the speaker. Select the position of the POLARITY switch which minimizes this hum.

4. A/B CHANNEL SELECT FOOTSWITCH. The footswitch supplied with the Enforcer permits remote switching between Channels A and B, and also allows both channels to be active simultaneously. Plug the footswitch into the A/B FOOTSWITCH jack on the Enforcer's back panel. Pushing the left button on the footswitch selects between the two channels, and pushing the right button selects between a single channel and both channels; LEDs above the two switches indicate channel status. When a single channel is selected, the LED representing that channel (either the green "Channel A" LED or the red "Channel B" LED) lights. When both channels are selected, the yellow "Both" LED lights. In addition, in the "Both" mode, either the Channel A or the Channel B LED will be on, indicating which channel will be active when you return to the single channel mode.

The footswitch is supplied with a 12.5 foot cord, which should be adequate in most cases. However, if you need to extend the cord, this is easily done using a 1/4" (phone) double female adaptor and a standard guitar cord or speaker cord with 1/4" phone plugs on each end.

5. PATCHING. The EFFECTS SEND jack on the back panel can be used to patch the Enforcer to an external signal processing device such as a phase shifter, equalizer, digital delay, etc. The output of the effect is then returned to the EFFECTS RETURN jack, as illustrated in Figure 4. For the patch cords, use unbalanced shielded cable.

FIGURE 4

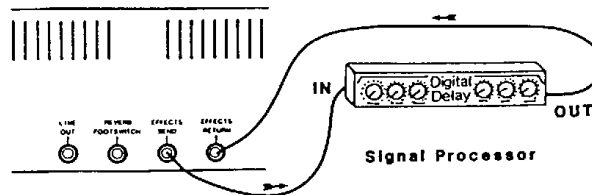

NOTE: Many effects devices, particularly battery-operated ones, are intended for guitar level signals (typically under one volt). The signals at the SEND/LINE OUT jack are at line level, and may cause the effect to distort. -If you encounter this problem, patch the effect between the guitar and one of the Enforcer's guitar inputs instead.

FIGURE 5

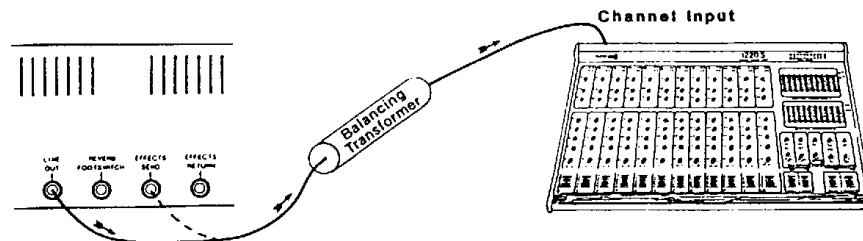

Either the EFFECTS SEND jack or the LINE OUT jack may be used as a direct send to a mixing console (see Figure 5). Use of the LINE OUT jack is preferred, since the EFFECTS SEND carries only the sound of the preamp, while the signal at the LINE OUT jack is derived from the speaker outputs, and thus represents the sound of the entire amplifier. Unbalanced shielded cable may be used to patch the amplifier to the console; however, the use of a balancing transformer (such as Shure Model A95UF) and standard balanced microphone cable is recommended because such a combination provides more immunity to interference from external sources, such as light dimmers and cash registers. In addition, if you use a balancing transformer you have the option of disconnecting the cable's shield from pin 1 of the 3-pin audio connector (a.k.a. Cannon or XLR plug) at one end of the mic cable. This eliminates the possibility of a ground loop forming between the Enforcer and the mixer. Just be sure that the shield is connected at one and only one end of the mic cable.

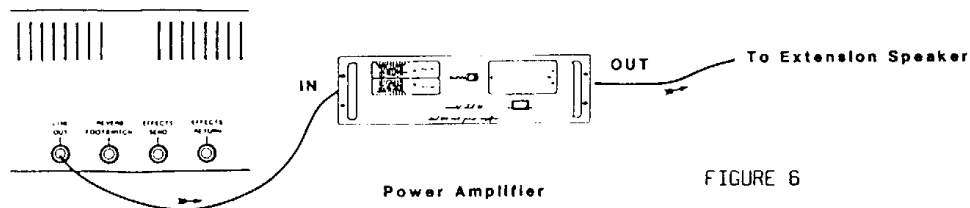

FIGURE 6

If you need more power than the 100 watts the Enforcer provides, an auxiliary power amplifier and speaker may be patched to the LINE OUT jack or to the EFFECTS SEND jack (again, use of the LINE OUT jack is preferred). This is illustrated in Figure 6. Use unbalanced shielded cable between the Enforcer and the power amplifier.

## 6. A FEW WORDS ABOUT TUBES.

6-1. REPLACING TUBES. If you have ever seen the innards of a vacuum tube, you are probably amazed that something that seems so fragile can perform so well for so long. Considering their construction, it is not surprising that tubes do occasionally need to be replaced. Not only do the filaments burn out (the filaments are the orange glowing wires nestled in the middle of the tube), but tubes also deteriorate with age, changing their tone quality, losing gain or power, or becoming microphonic or noisy. If your amp doesn't sound as good as it used to, or if one or both channels quits, it may be time to change some of the tubes. There are two types of tubes in the Enforcer: 12AX7A's which are the preamp tubes and 6L6GC's, the output tubes.

6-1-1. PREAMP TUBES. There are four 12AX7A preamp tubes in the Enforcer. These are the small tubes on the right side of the amp, looking in from the back. When one of these tubes goes bad, one or both channels may stop working, become excessively noisy or prone to microphonic ringing, rattle or squeal, or lose clarity of tone. It is helpful to carry an extra 12AX7A with you for use as a spare. This allows you to substitute it for each of the ones in the amp one by one to isolate the defective tube.

Due to the high gain of the stages following it, the first preamp tube (the one located nearest the input jacks) is the one most prone to microphonic and noise problems. Try swapping all four of the Enforcer's 12AX7A's around to find the best tube for this position.

Microphonic tubes can often be located by tapping them while the amplifier is turned on-- the sound of the tapping will be heard most loudly in the speaker when the offending tube is being tapped. Unfortunately, even though a tube is new, it may be microphonic or excessively noisy. The best solution to this problem is to use tubes specially selected for low microphonics (these are available through many music stores). An expensive alternative is to buy several tubes at once, and weed out the microphonic and noisy ones yourself. If neither of these alternatives is possible, try each tube in each tube location until you obtain the best results.

Whenever you replace a tube, turn the Enforcer's AC power OFF.

A tube may be removed from its socket by grasping it between your fingers and gently rocking it as you pull it out. When replacing one of the preamp tubes, note that the gap between its pins should point directly toward the back of the chassis (where the output jacks are located). The tube should go in stiffly, but without having to exert too much pressure. DO NOT force a tube into its socket-- doing so could damage the tube. If you accidentally bend one of the pins, bend it back carefully (some people recommend using the barrel of a ball-point pen for this operation), and make sure that it is parallel to the other pins before trying to reinsert it into the socket.

12AX7A's are also known by the names 6681, 7025 and ECC 83.

6-1-2. OUTPUT TUBES. The output tubes are the four large tubes near the center of the chassis. A bad output tube can cause the amplifier to lose power, sound muddy or distorted, and make rattling sounds in the speaker when a note is played. If these symptoms are observed, or if the plate of the output tube (the black or grey metal cylinder inside the tube) is glowing red or if the filament (the orange glowing wire in the very center of the tube) is not lit, you probably have a defective 6L6GC. Since the output tubes have to work together, all four should be replaced at the same time, and they should all be of the same brand. If a tube fails during a performance, you can usually make it through the night by putting the amplifier into its 60 Watt mode, which turns off two of the tubes. If this does not clear up the sound, try swapping the two tubes closest to the output transformer with the other two output tubes (it is these other two that are active in the 60 Watt mode). Replace the tubes as soon as possible.

Always turn the amplifier OFF when removing and replacing tubes. To remove an output tube, hold the two spring clips away from the base of the tube and rock the tube gently as you pull it out of the socket. Before replacing the tube, bend these clips in slightly to ensure that they will hold the tube in place.

**WARNING:** The output tubes get very HOT when they are on. Let them cool adequately before removing them from their sockets.

**NOTE:** Occasionally, the center stem of a 6L6 will break off. As long as the silver or black coating on the inside of the glass has not turned white, the tube is probably still good. The remains of the alignment tab on the stem should still be visible; insert the tube into its socket with this tab pointing straight back toward the rear of the chassis (where the output jacks are located). Before turning the amplifier back on, compare the orientation of the broken tube's plate with that of the other output tubes-- they should be pointing in the same direction. When you turn the amp back on, check that the filament of the tube with the broken stem is glowing; if it is, the tube is in its socket correctly.

Other names for the 6L6GC are 5881 and KT-88.

6-2. WHAT IS THE "TUBE SOUND"? Since the early sixties when solid state guitar amplifiers were first introduced, the question of whether tube amps or solid state amps were better has been a subject of debate. Frequently such debate generates more heat than light, but it is clear that many people can hear a difference between the two types. Which type is "better" is entirely a matter of personal preference. Tube amps often produce more noise and hum than solid state amps; tubes are physically fragile; their characteristics change as they age; they generate quite a bit of heat even when idling; and their filaments burn out eventually, necessitating tube replacement. With all these drawbacks it doesn't seem that anyone would choose a tube amp over a solid state amp, but of course they do. An elusive quality called the "tube sound" is the reason prompting the choice.

There are almost as many words used to describe the tube sound as there are guitarists. Nearly all descriptions, however, relate to the manner in which the amplifiers distort. When an amplifier distorts it adds frequencies to the signal not originally present-- the nature and degree of these added frequencies, and the manner in which the amplifier passes from non-distortion into distortion determine the ultimate sound of the amp. One amplifier might generate mostly second harmonics, another may generate all the even and odd harmonics of a signal, and still another may generate only even harmonics-- each amplifier will have a different characteristic sound.

Most of the distortion in instrument amplifiers is harmonic distortion, and most of the harmonic distortion is a product of clipping. Clipping can be classed in two categories- hard clipping and soft clipping. Hard clipping, which is characteristic of most solid state amps, has a very high harmonic content and tends to sound harsh.

Soft-clipping is a characteristic of tube amps (and of the CMOS and FET circuitry contained in many SUNN products). With soft clipping the higher harmonics tend to be of lower amplitude than those of hard-clipped signals, and with tube amps the clipping threshold (the signal level at which clipping begins) is more forgiving, allowing for some increase in output as the input signal rises. On signal peaks the signal is flattened, but it is flattened gradually and not chopped off abruptly as it is with hard clipping. The result is a softer, warmer tone, and one that gives the player more instantaneous control over his sound. By picking his strings harder the guitarist can add bite and sustain to the note in a very smooth and controlled way, without the "stiffness" that seems inherent in so many solid state amps.

There are other factors affecting the sound as well, including the non-symmetrical manner in which tubes clip the signal (the positive peaks are treated differently from the negative peaks), the high slew rate that tubes exhibit, and some subtle effects introduced by the output transformer and the high voltage power supplies. There is no final answer to the question of what makes a tube amp sound different from a solid state amp, nor is there any objective way of deciding which produces a better sound, but those who are sold on tubes will doubtless continue to use them for years to come.

7. OPERATING HINTS AND SAMPLE SETTINGS. The Enforcer was designed to be as versatile an amplifier as possible, one that takes full advantage of the unique characteristics of vacuum tubes and offers the guitarist a wide spectrum of sounds from which to choose. One of the keys to this versatility is the inclusion of two channels, each having its own distinctive personality: Channel A, with its pre-distortion EQ, treats the signal in a different way than Channel B, which employs post-distortion EQ. Either channel may be played dirty, clean or in-between, and each channel has its own character no matter how it is played. You may prefer the clean sound of Channel A and the dirty sound of Channel B or vice-versa. Or you might like them both clean or both dirty. By using the A/B footswitch, you can instantly choose between the two sounds, or you can combine them into a third unique sound. With both channels set up for a similar degree of overdrive, the combined effect is a blend of the two sounds; with the two channels set up to sound radically different, the result may sound more like you are playing through two different amps at the same time. Take some time to become familiar with the distinctive qualities of the two channels, and experiment with different combinations of sounds. The power of the Enforcer as a musical tool will become apparent as you explore its potential.

Here are some rules of thumb:

- \* For a clean sound, turn down a channel's DRIVE control and turn that channel's LEVEL control up.

- \* For sustain and distortion, turn up the channel DRIVE, and turn the channel LEVEL down.

- \* DRIVE settings between 2 and 4 allow you to play clean by picking softly and to add some "edge" and sustain to the note by picking the strings a little harder. (One of the nicest features of tubes is the way they go from clean into overdrive. With the right DRIVE setting, you can get a wide variety of sounds without having to readjust your amplifier-- it's all in the touch.)

On the next page are some sample control settings. Bear in mind that because guitars and playing styles vary so much, these suggestions are only intended as starting points; however, they should get you into the ballpark. The blank front panel drawings can be used to record your own settings.

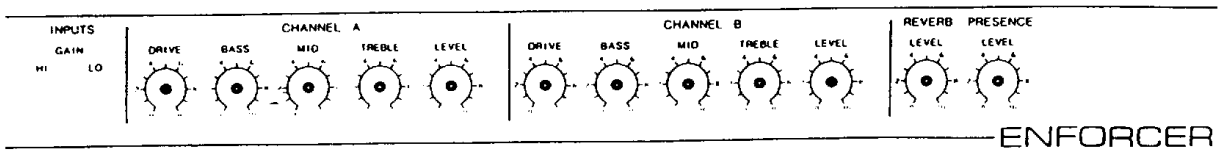
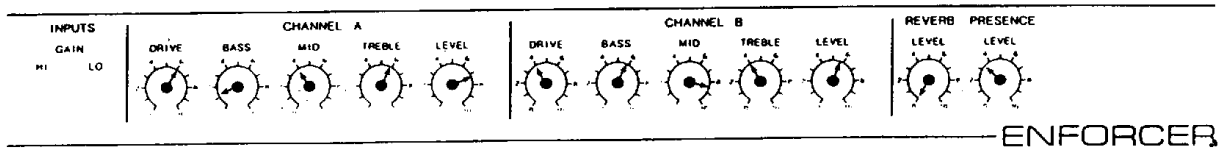
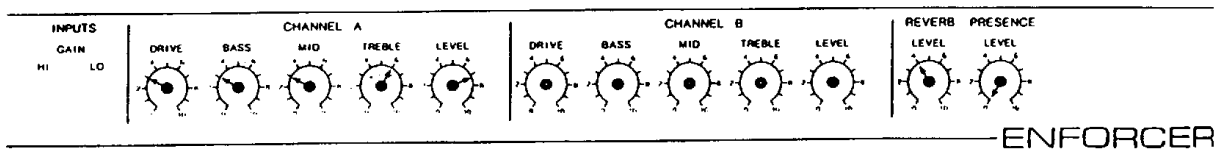
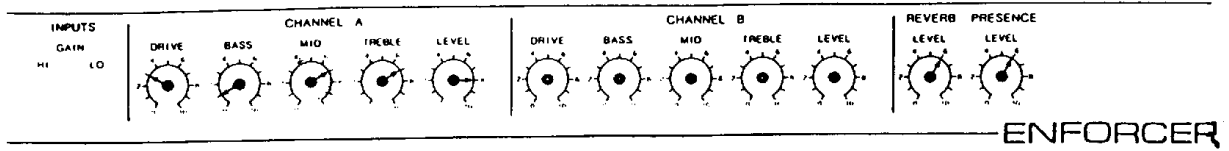

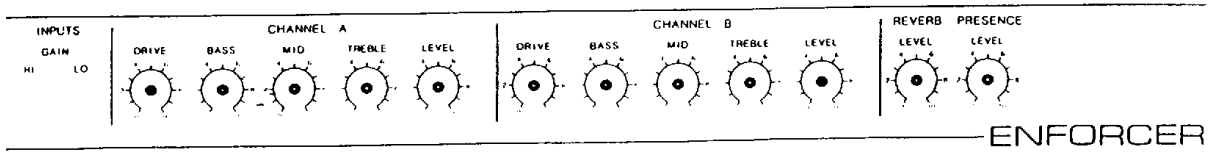
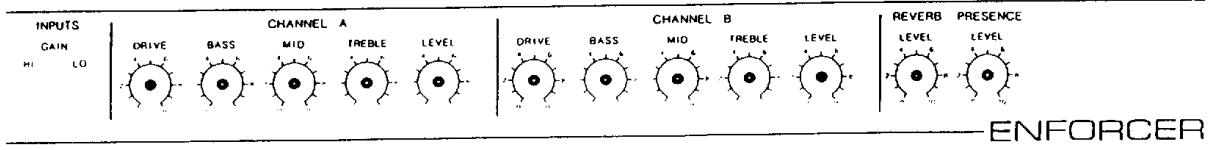
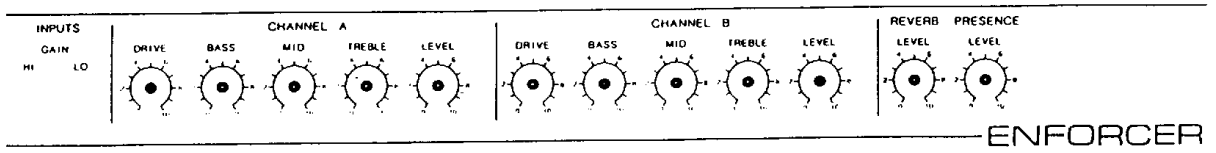
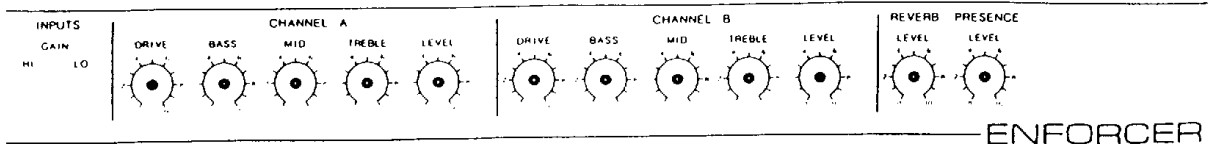

8. UPKEEP AND SERVICE. The Enforcer has been designed to give you years of trouble-free service. However, it does contain vacuum tubes which occasionally wear out, burn out, break or become microphonic. These should be tested from time to time and replaced when necessary. Except for the tubes and the fuse, the Enforcer contains no user-serviceable parts. In the event of amplifier failure, refer the problem to a qualified electronic technician. Contact your dealer for the location of the nearest SUNN Authorized Service Center.

9. SUNN MUSICAL EQUIPMENT COMPANY'S LIMITED WARRANTY.

SUNN Musical Equipment Company warrants this new product to be free from defective materials and workmanship for one year from date of purchase to the original owner when purchased from an AUTHORIZED SUNN DEALER according to the following conditions:

The purchaser is responsible for completing and mailing to SUNN, within 15 days of purchase, the warranty application enclosed with each product. Upon receipt of the warranty application, SUNN will issue a warranty validation sticker that must be affixed to the product. Where a warranty validation area has not been provided on a few SUNN products, the validation sticker is to be affixed to your original proof of purchase and presented at the time of warranty service. PROOF OF PURCHASE ON UNREGISTERED EQUIPMENT IS NOT SUFFICIENT FOR RECEIVING IN-WARRANTY SERVICE. In the event you do not receive your validation sticker within 60 days of mailing, you are to notify SUNN Musical Equipment Company in writing immediately. The purchaser has the sole responsibility for completing and mailing the warranty application.

Meters, meter light bulbs, vacuum tubes and lighting fixtures carry a 90 day warranty from date of purchase. There is no warranty on gels or lamps used in portable lighting systems.

SUNN products that have been subject to accident, alterations, abuse, rental or defacing of the serial number are not covered by this warranty. Loudspeakers and drivers misuse due to overpowering or improper installation resulting in torn, burned or charred components will not be covered by this warranty.

The normal wear and tear of appearance items such as vinyl covering, handles, corners, casters and knobs are not covered under this warranty.

If your SUNN product requires service during the warranty period, SUNN will repair or replace, at its option, defective materials provided you have identified yourself as the owner of the validated product to any SUNN authorized service center or contact SUNN for service assistance. Transportation charges to and from an authorized service center or factory for SUNN products and components to effect repairs shall be the responsibility of the owner. In the event a product is to be returned to SUNN for repairs, a written return authorization from SUNN must be obtained prior to shipping.

SUNN is not liable for any incidental or consequential damages resulting from any defect or failure of this instrument other than the repair of the SUNN product subject to the terms of this warranty. This warranty gives you specific legal rights, and you may also have other rights which vary from state to state. This warranty is expressly in lieu of all other agreements and warranties, expressed or implied, except as may be otherwise required by law.

Thank you for choosing SUNN!



## SERVICE BULLETIN

### INSTALLING RELAY BOARD IN THE ENFORCER

The relay p.c. board (P/N 20-0217) was created in response to a crosstalk problem between Channels A and B in SUNN Enforcer tube amplifiers manufactured prior to August, 1984. In these amplifiers, when Channel A is set up for a quiet and clean sound, and Channel B is set for distortion, the distortion from Channel B "bleeds" over into Channel A. Installation of the relay board solves this problem, and at the same time improves the dynamic range and sound of the amplifier. The modification required is of moderate difficulty and should only be attempted by skilled electronic technicians. Carefully follow the procedure outlined below. Before starting, make sure that the Enforcer is not plugged in.

#### A. REMOVE THE CHASSIS FROM ITS CABINET.

1. Remove the two large phillips screws from the side of the cabinet,
2. Remove the six phillips screws from the top of the cabinet,
3. Slide the chassis out of the cabinet. Note: Due to weight of the transformers, the chassis is quite heavy; be careful not to drop the chassis as you remove it.

B. PREPARATION. For the sake of orientation, set the chassis down with the transformers sitting on your bench and the front panel knobs facing you-- the power transformer should now be on your right.

1. Remove the screws holding the reverb pan bracket to the chassis and set the reverb pan aside. By turning the pan around, it may be set on the bench behind the Enforcer without having to unplug the reverb cables.

Inside the chassis are three printed circuit boards; the two we are concerned with are the large one with its solder side up that supports all of the tubes, called the "main p.c.," and the narrow one attached to the front of the chassis with all of the rotary pots on it, called the "front panel p.c."

2. The main p.c. is supported by eleven standoffs. The first step is to remove the solder (use solder wick or a vacuum desoldering tool) from the ends of two of the standoffs; one of these is positioned between the two nine pin miniature tube sockets on the left end of the main p.c., and is approximately 2" from the front edge of the main p.c.; the second standoff is located between the second and third nine-pin miniature tube socket and is about 1/2" from the front edge of the main p.c.

3. Remove the knobs from all pots except the Channel B DRIVE pot.
4. Remove the nuts from all pots except the Channel B DRIVE pot.
5. Slip the front panel p.c. out of the front panel, being careful not to damage the flex jumpers connecting the p.c. boards together.

FIGURE 1

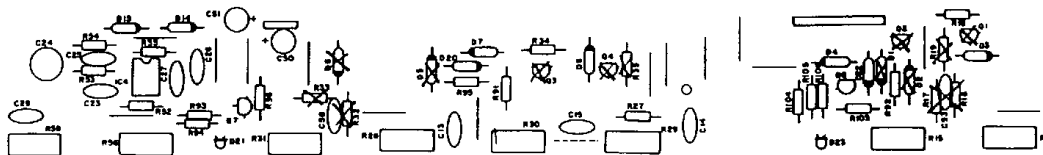

C. REWORK THE FRONT PANEL P.C.

1. PARTS REMOVAL. Refer to Figure 1, and remove the following parts from the front panel p.c. board:

- a. Channel A.
  - D1, D2 (1N458)
  - Q1, Q2 (TIS 74)
  - R16 (330 K)
  - R17 (100 K)
  - R19 (1 meg.)
  - C53 (100 pf.)
- b. Channel B.
  - D5, D6 (1N458)
  - Q3, Q4 (TIS 74)
  - R32 (100 K)
  - R33 (330 K)
  - R35 (1 meg.)

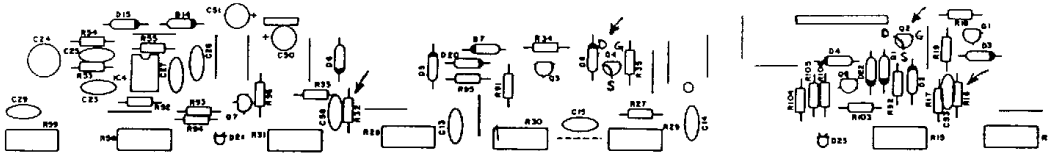

FIGURE 2

2. INSTALL NEW PARTS. Refer to Figure 2 and add the following parts:

- a. Channel A:
  - 470 K, 1/4 watt resistor in location R16,
  - Small jumper across the former Drain and Source connections of Q2.
- b. Channel B:
  - 470 K, 1/4 watt resistor in location R32,
  - Small jumper across the former Drain and Source connections of Q4.

3. CHECK YOUR WORK.

a. Trace the signal path from the wiper of the Channel A LEVEL pot through the newly installed 470 K resistor, across the circuit board and through the new jumper to the second pin of the flex jumper in the middle of the front panel p.c. All components except the 470 K resistor should have been removed from that signal path.

b. Similarly; trace the signal path from the wiper of the Channel B LEVEL pot through the 470 K resistor to the same pin of the flex jumper, checking for any unremoved components.

c. Make sure there are no solder bridges or cold joints.

4. REINSTALL FRONT PANEL P.C.

- a. CAREFULLY insert front panel p.c. pot shafts through holes. Make sure channel indicator LEDs are properly situated.
- b. Put nuts onto pot shafts and tighten-- do not over-torque the nuts.
- c. Rotate all pot shafts fully counter-clockwise. With the knobs pointing to the number 0, push the knobs onto the shafts; leave enough of a gap between the knob and front panel to allow the control to be turned without binding.

D. INSTALLING RELAY BOARD.

1. With the relay p.c. oriented so that the component side is up and the edge with three wires (yellow, black and red) is toward the back of the chassis, solder the wires to the points indicated in Figure 3. The table (Figure 4) summarizes these connections.

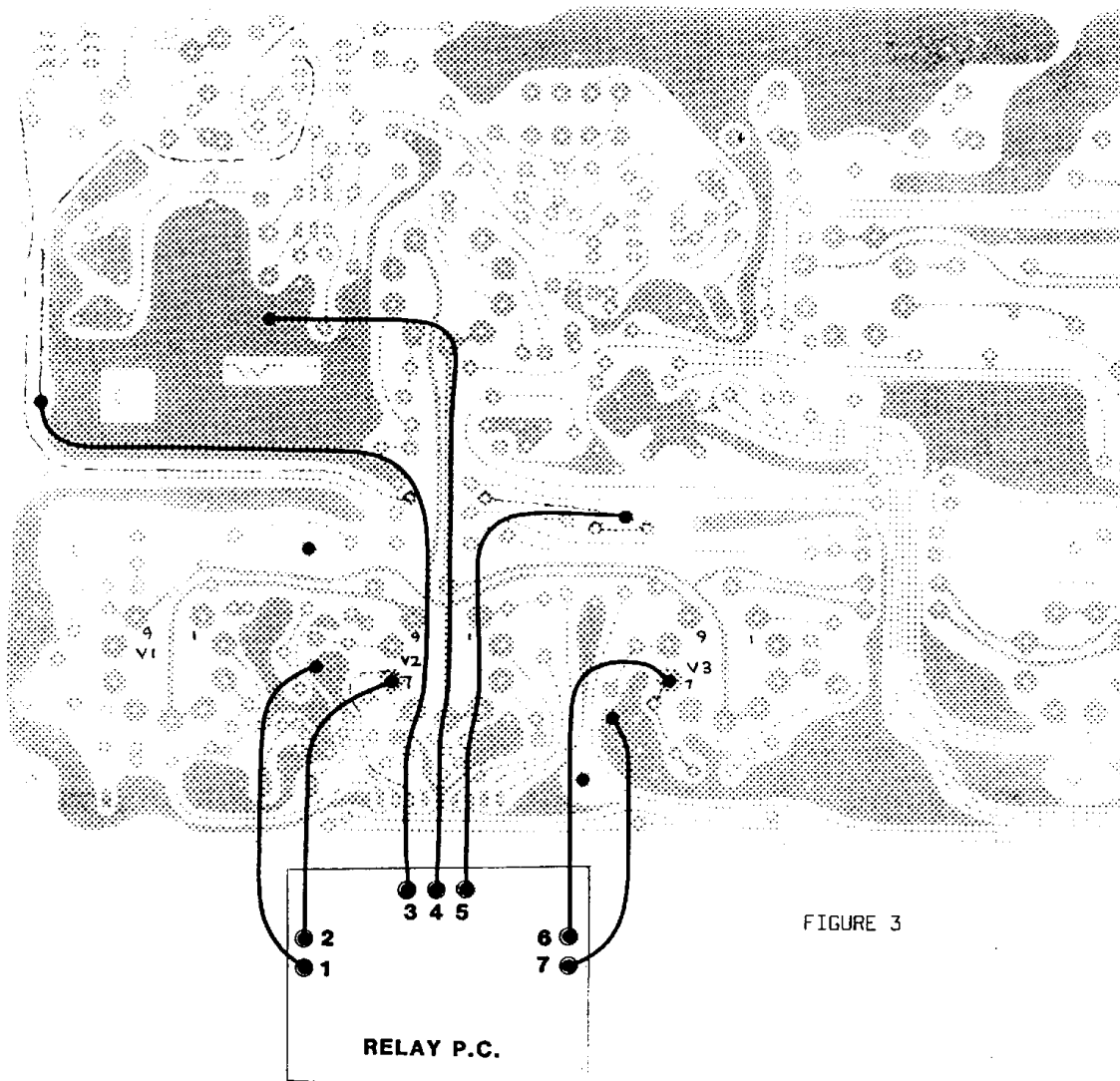

FIGURE 3

FIGURE 4

WIRE NUMBER	WIRE COLOR	CONNECTION POINT
1	Black	Channel A ground
2	Red	Pin 7, V2
3	Yellow	Channel A select* line
4	Black	Low voltage supply ground
5	Red	Channel B select* line
6	Red	Pin 7, V3
7	Black	Channel B ground

NOTE: Each group of wires (above) is twisted together; i.e., wires 1 and 2 form a twisted pair, etc.

2. Inspect your connections to make sure none of the wire strands is causing a short to another pad or trace on the main p.c.
3. You will be installing the relay p.c. with its solder side facing the solder side of the main p.c.; trim any leads that look like they may cause shorts when the boards are mated. Make sure no wire bits are left lying on the circuit boards or in the chassis.
4. Using the spacers and screws supplied, mount the relay p.c. to the two main p.c. standoffs you de-soldered in step B 1.
5. Visually inspect for shorts between the relay and main p.c.'s.

E. TESTING.

1. Plug the footswitch into the footswitch jack, plug an 8 ohm load into the 8 ohm/60 watt speaker jack, patch a 1 kHz signal into one of the input jacks, patch an oscilloscope into the LINE OUT jack.
2. Set all three lighted rocker switches in their down positions and plug in the amplifier. Turn on the MAINS switch and allow the amp to warm up for a minute. Activate the STANDBY switch, adjust channel settings so that a signal appears at the output of the amplifier. Switch channels with the footswitch and verify that only Channel A is active when it is selected, only Channel B is active when it is selected, and both channels are active when "BOTH" is selected. Switch the power off and unplug the amplifier.

E. PUT THE AMPLIFIER BACK TOGETHER.

1. Reinstall the reverb pan.
2. Return the chassis to its cabinet.

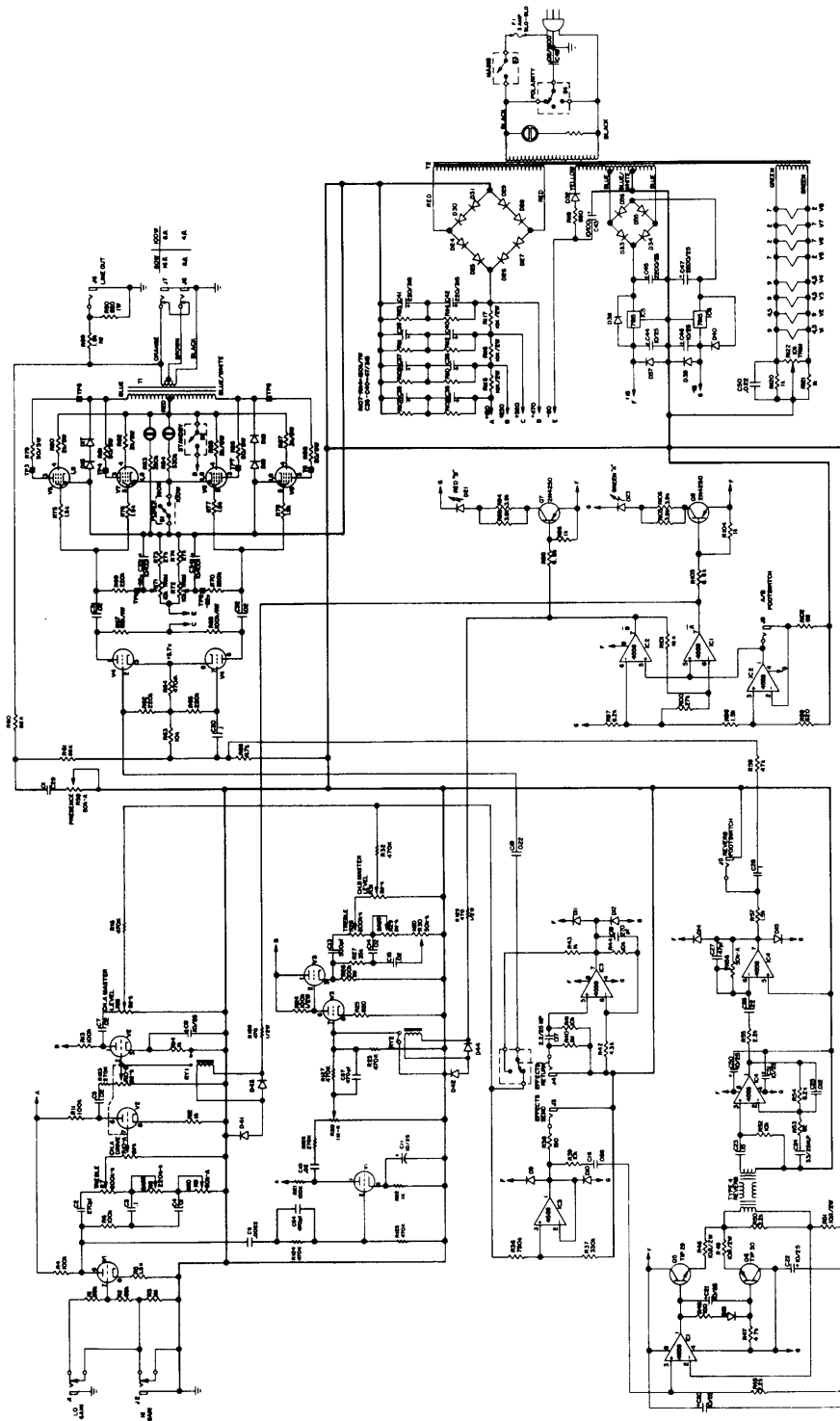

NOTE: ALL PARTS SHOWN ARE APPROXIMATE. ALL OTHER RESISTORS ARE 1/4 WATT.  
 ALL CAPACITORS ARE 50VDC UNLESS OTHERWISE SPECIFIED.  
 ALL VOLTAGE MEASUREMENTS SHOULD BE TAKEN WITH COMMONS SETTING.  
 ALL VOLTAGE MEASUREMENTS SHOULD BE TAKEN WITH COMMONS SETTING.  
 USE VOLTMETER 1000 OHM.

ENFORCER SCHEMATIC  
 Rev. 1/74

REVISIONS		DATE	APPROVED
LTR	DESCRIPTION		

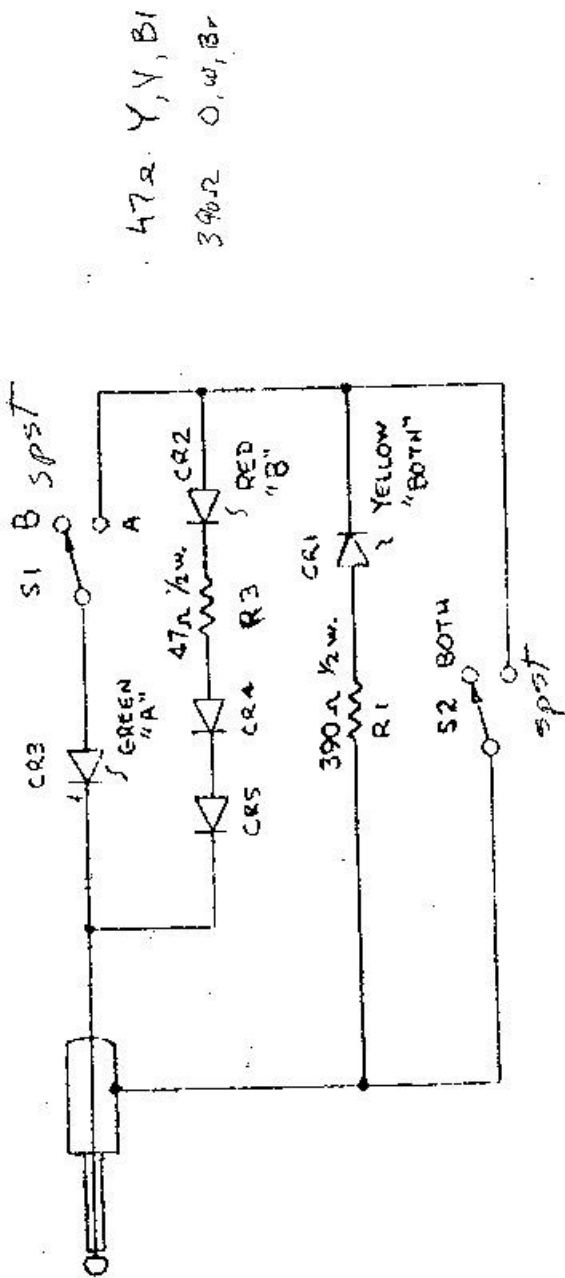

47Ω Y, V, B1  
390Ω O, W, B1

NOTES:

- DIODES CR1, CR2, CR3 ARE LEDs
- DIODES CR4, CR5 ARE TYPE 1N458
- S1 AND S2 ARE "PUSH-ON, PUSH-OFF" PUSHBUTTON SWITCHES

FOR SUNN<sup>o</sup> Engineer

TOLERANCES UNLESS OTHERWISE SPECIFIED		FRACTIONS DEC ANGLES	
±	±	±	±
APPROVALS	DATE	SCALE	DRAWING NO.
DRAWN N. J. [Signature]	DATE 9/1/84	N/A	A 96-1610-0
CHECKED		DO NOT SCALE DRAWING	SHEET
UNIVERSAL FOOTSWITCH			