

SERVICE MANUAL

VOX VT50



TABLE OF CONTENTS

ASSEMBLY SKETCH : 2-3

SCHEMATIC DIAGRAM: 4-5

PARTS LIST: 6-7



Issued: Mar.19, 2009

Ver.1.0

©2009 VOX AMPLIFICATION LTD.

DWG. NO. ASSY0261-01

NO	DESCRIPTION	SPECIFICATION	Q'TY	
1	JACK PCB ASSY	VT15/30/50	1	
2	MAIN PCB ASSY	VT50/100	1	
3	POWER PCB ASSY	VT50	1	
4				
5	MAIN CHASSIS	EG1 1f	1	
6	FRONT PANEL	PVC 0.3t HAIR LINE BK	1	
7	REAR PANEL	PS 0.3t	1	
8	VOLUME KNOB	ABS (CHIKEN HEAD) CLEAM	8	
9	ROUND KNOB	ABS BK	3	
10	LED BUSHING	φ5	1	
11	RUBBER BUSHING	φ12	1	
12	SCREW	MWS 4x10 NI	5	15kgf.cm
13	SCREW	MBSSW 3x6 NI	17	8kgf.cm
14	SCREW	TBQSSW 3x8 BK	3	8kgf.cm
15	SCREW	TPQS 3x6 Ni	1	8kgf.cm
16	FLANGE NUT	M4 NI	5	
17	TOOTH WASHER	φ4	1	
18	CHASSIS FIX	Ni	4	
19	RUBBER FOOT	SMALL - 11mm	2	
20	SCREW	TBQS 3x8 BK	2	4kgf.cm
21	TRANS		1	
22	FUSE		1	
23	POWER SWITCH	APS-1101HV0	1	
24	INLET/FUSE HOLDER	SC-8F-21 or HF-301RT2	1	
25	CABLE TIE		7	
26	VOLUME NUT	M7 Zn	11	7kgf.cm
27	VOLUME WASHER	φ7	3	
28	JACK NUT	M10 NI PLATING	1	4kgf.cm
29	JACK WASHER	PLASTIC BK	1	
30	JACK NUT	M11 PLASTIC BK	1	4kgf.cm
31	JACK NUT	M11 PLASTIC RED	1	4kgf.cm
32	205/SLEEVE WIRE ASSY	φ3 NI	1	
33	205/RING TERMINAL WIRE	M3 NI	1	
34	TUBE	12AX7EH	1	
35	TUBE RETAINER	SPRING SUS φ1	1	
36	PVC TUBE	φ5(OD)xφ3(IN)x25(L)	2	
37	HEAT SINK	AL EXTRUDING(80x30x80)	1	
38	PCB SUPPORT	BRASS 30mm NI F.M	2	4kgf.cm
39	DC FAN	KF0510SSL-01	1	
40	SCREW	MPS 3x14 BK	2	8kgf.cm
41	EARTH RING	Sn 12x17x0.3t	3	
42	JACK WASHER	φ12 FIBER	4	
43	PCB SUPPORT	BRASS 15mm	7	
44	SCREW	TPQS 3x14 BK	2	8kgf.cm
45	WASHER	φ3 BK	2	
46	TACT KNOB "A"	RUBBER φ9	9	
47	TACT KNOB "B"	RUBBER φ7	1	
48	AL FOIL	27x35x0.05t	1	

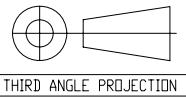
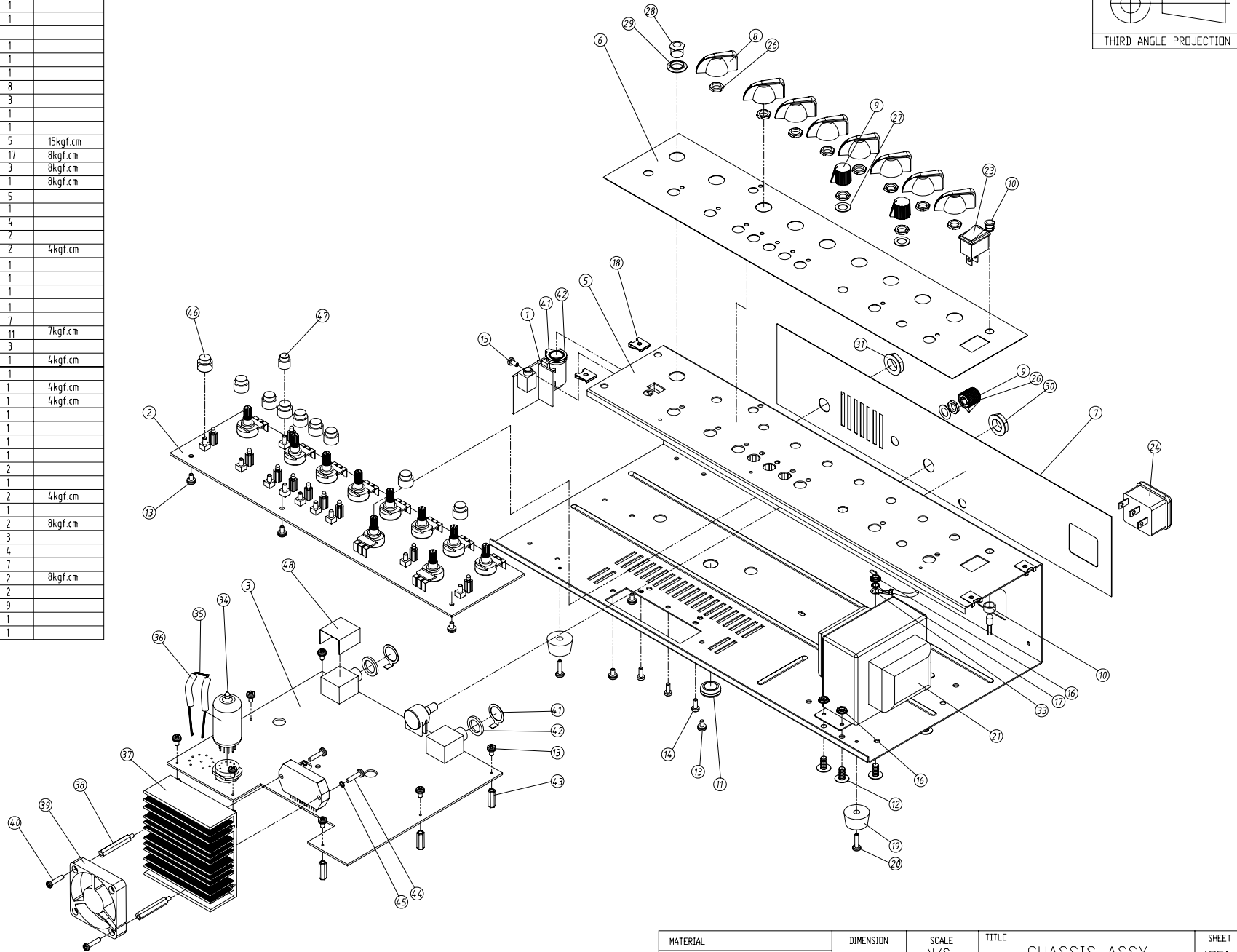

THIRD ANGLE PROJECTION

MATERIAL	DIMENSION	SCALE	TITLE	SHEET
THICKNESS	mm	N/S	CHASSIS ASSY	10F1
FINISH	MODEL	VT50	DWG. NO.	VER.
			ASSY0261-01	A
TOLERANCE UNLESS NOTE	DRAWN	DATE	 Kimanson Instruments CO., Ltd.	
DIMENSIONAL	H.I.KIM	2009.01.04		
HOLE CENTERS	CHECKED	DATE		
DIAMETERS	APPROVED	DATE		
ANGULAR				

REV. NO.	REV. DATE	DESCRIPTIONS OF REVISION
C		
B		
A		

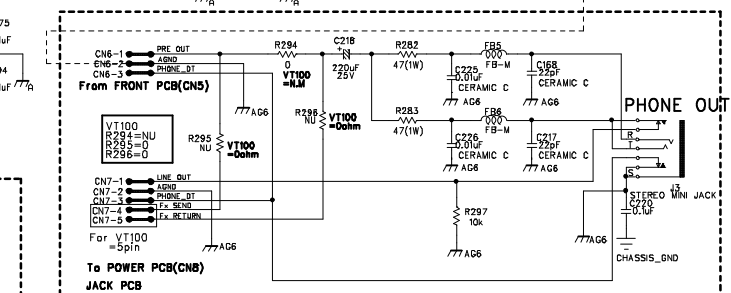
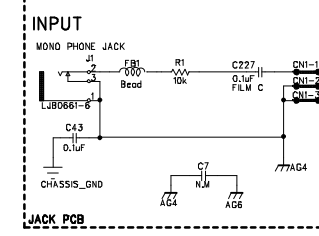

N.U

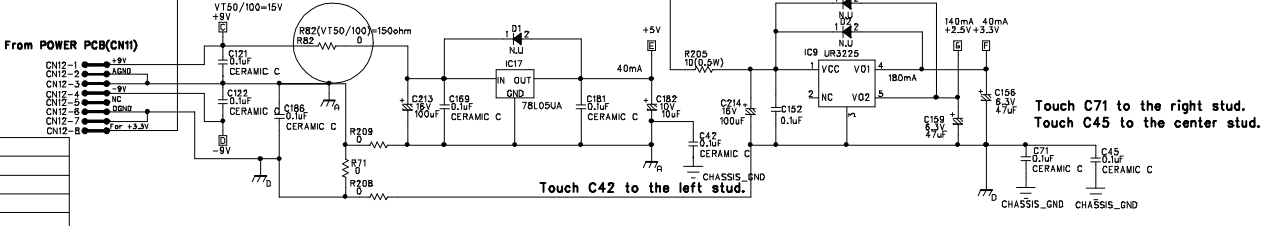
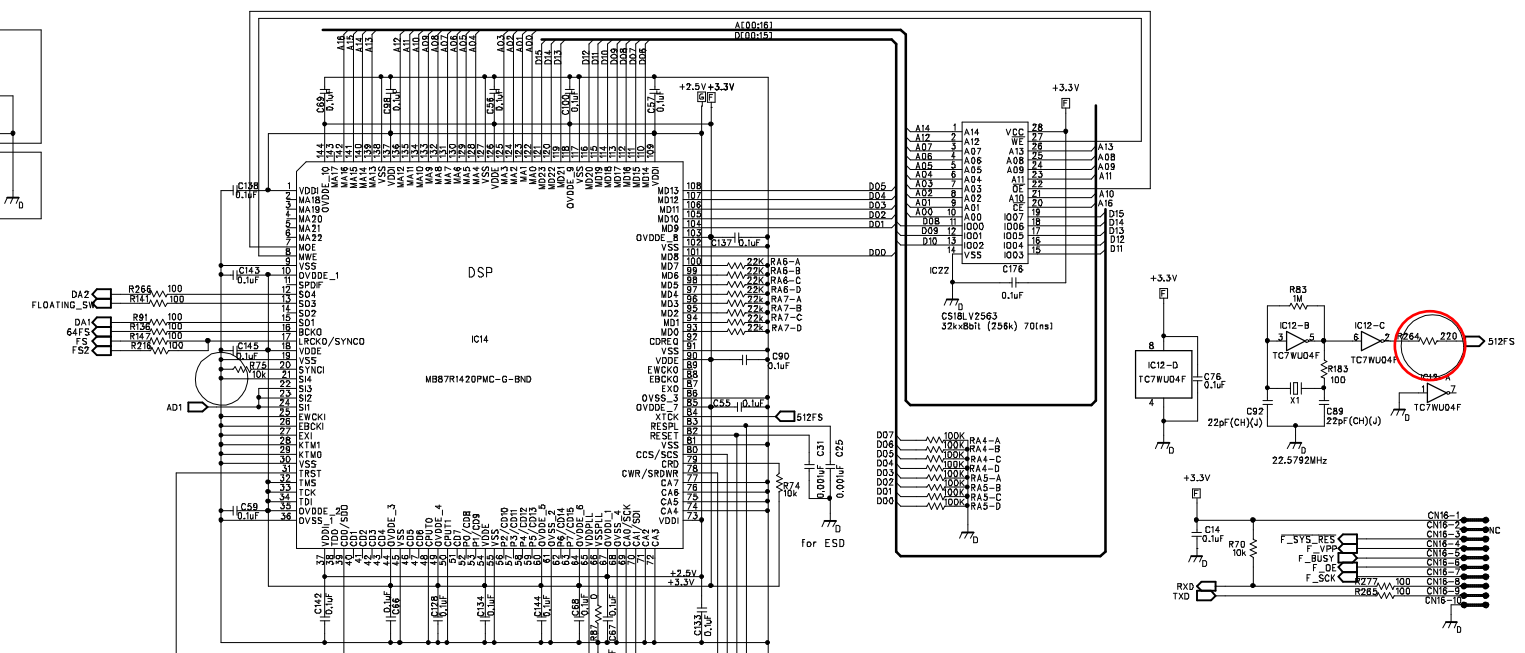
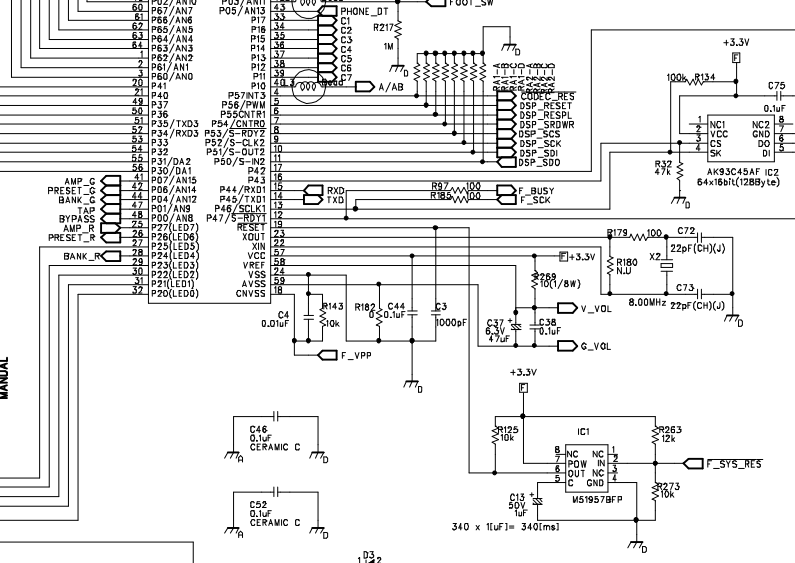
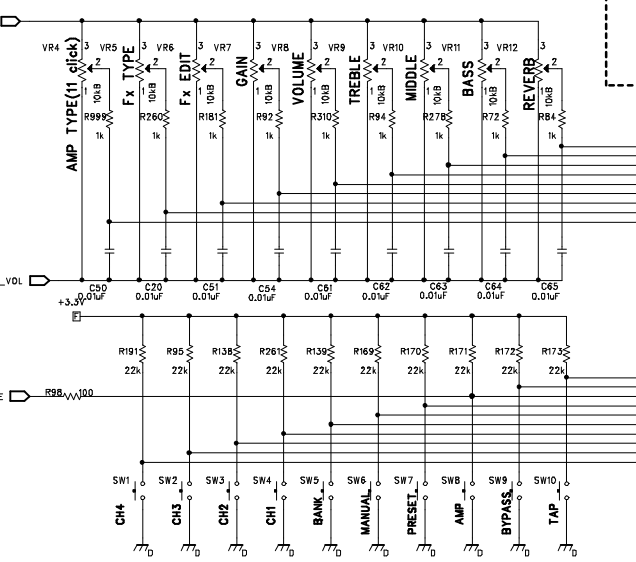
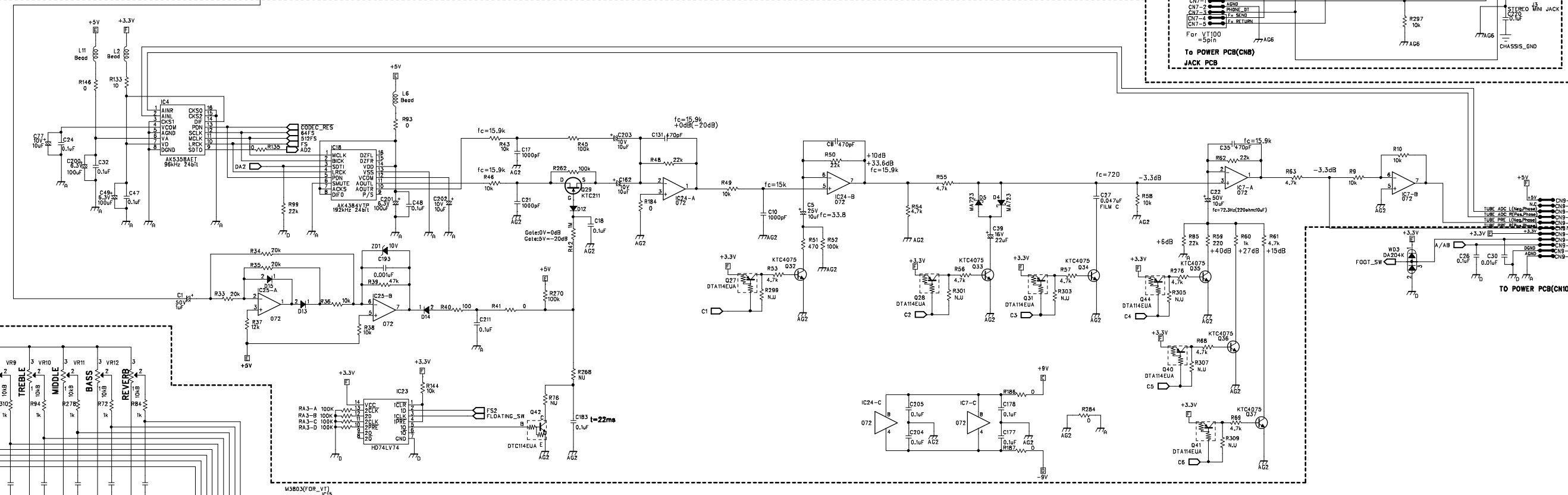





Table with 4 columns: MARK, REVISION REASON, DATE, REVISED BY.

VOX VT50 Parts List

 = SAFETY CRITICAL COMPONENT.

Component must be replaced only by the component specified in this list.

Part Number	Category	Part Name	Location	Reference	QTY
530000001086	CHIP INDUCTOR	HH-1M2012-121	JACK PCB	FB1,FB5,FB6	3
530000001256	HARNESS	SHIELD WIRE UL2547 3P 115MM	JACK PCB		2
530000001147	HARNESS	3P WIRE BOARD IN 100MM	JACK PCB		1
530000001100	PHONE JACK	BPJ-BNB-6.5(NUT/BLACK)	JACK PCB		1
530000001104	PHONE JACK	PJ3039 (3.5PIE)	JACK PCB		1
530000001094	OPAMP	NJM072 (SMT)	MAIN PCB	IC5	1
530000000813	OPAMP	NJM4556M	MAIN PCB	IC3	1
500324018020	DA CONVERTER	AK4384ET-E2	MAIN PCB	IC16	1
50032001255	CPU	M38039G8H-603HP U0	MAIN PCB	IC15	1
500320012334	DSP	MB87R1420PMC-G-BND	MAIN PCB	IC14	1
530000000183	SRAM	CS18LV02563AC-70	MAIN PCB	IC22	1
530000000189	RESET IC	KIA7125FV	MAIN PCB	IC1	1
500324018021	AD CONVERTER	AK5358AET-E2	MAIN PCB	IC11	1
530000000180	EEPROM	AK93C45AF	MAIN PCB	IC2	1
530000001095	3-INVERTOR	TC7WU04F	MAIN PCB	IC12	1
530000001096	DIGITAL TR	DTC114EUA	MAIN PCB	DT1,DT2,DT3,DT4,DT17	5
530000001097	REGULATOR	78L05UA	MAIN PCB	IC17	1
530000001098	REGULATOR	UTC UR3325	MAIN PCB	IC9	1
530000000271	CHIP TRANSISTOR	KTA2014	MAIN PCB	Q5	1
530000000275	CHIP TRANSISTOR	KTC2875	MAIN PCB	Q1	1
530000000159	DOUBLE DIODE	DA204K	MAIN PCB	WD1,WD2,WD3	3
530000000144	CHIP INDUCTOR	HH-1M2012-600	MAIN PCB	L21,L17,L20	3
530000001087	CRYSTAL	8.00MHZ	MAIN PCB	X2	1
530000001088	CRYSTAL	22.5792MHZ	MAIN PCB	X1	1
530000000288	VOLUME	VR RV160-40-15S-B10K-C0	MAIN PCB	VR3, VR6~VR12	8
530000000289	VOLUME	VR RV160-40-15S-B10K-C11 (11CLICK)	MAIN PCB	VR4, VR5	2
530000000265	TACT SWITCH	ATS-1230B (K=9.5MM)	MAIN PCB	SW1~SW10	10
530000000208	LED	LED RED 3M/M DLL-B5131Q	MAIN PCB	LED5~LED11	7
530000001102	LED	3RG9HW-2-A	MAIN PCB	LED2,LED3,LED4	3
530000000762	CONNECTOR	WAFER(GIL-S-3P-S2T2)	MAIN PCB	CN2,CN5	2
530000001148	HARNESS	 8P LEAD WIRE BOARD IN 230MM	MAIN PCB		1
530000001149	HARNESS	 5P LEAD WIRE BOARD IN 320MM	MAIN PCB		1
530000001225		LED SUPPORT SW 4010 - 10MM	MAIN PCB		7
530000001226		LED SUPPORT SW 4009 - 9MM	MAIN PCB		3
530000001124		TACT KNOB "A" NBR 9PIE	MAIN PCB		9
530000001125		TACT KNOB "B" NBR 7PIE	MAIN PCB		1
530000001211	POWER IC	STK404-100SC-E	POWER PCB	IC1	1
530000001091	OP-AMP	NJM072D (DIP)	POWER PCB	IC6,IC20	2
530000001212	REGULATOR	MC7915	POWER PCB	IC8	1
530000001213	REGULATOR	MC7815	POWER PCB	IC19	1
530000001103	LED	3O4HD-7	POWER PCB	LED2	1
530000000290	VOLUME	RV162-20-15SP-B100K	POWER PCB	VR13	1
530000000137		BEAD CORE SAT2550L	POWER PCB	L3,L2,FB1,FB2	4
530000000804		BRIDGE DIODE KBU4K	POWER PCB	D6	1
530000000142	BRIDGE DIODE	W04M	POWER PCB	D7	1
530000000150	DIODE	1N4002	POWER PCB	D10,D11,D25,D26,D2,D8,D9	7
530000000151	DIODE	1N4148	POWER PCB	D5,D1	2
530000001203	ZENER DIODE	1N5243B,T	POWER PCB	D14	1
530000001205	ZENER DIODE	1N4733B,T	POWER PCB	D4	1
530000000277	TRANSISTOR	KTC3198-GR	POWER PCB	Q7,Q8,Q9,Q11,Q16,Q21,Q22,Q17	8
530000000268	TRANSISTOR	KTA1266GR	POWER PCB	Q10,Q14,Q23	3
530000000273	TRANSISTOR	KTC2874	POWER PCB	Q13	1
530000001228	TRANSISTOR	KTC3200GR,T	POWER PCB	Q24	1
530000000838	CONNECTOR	MOLEX 5051 2P WAFER	POWER PCB	CN2	1
530000001116	CONNECTOR	WAFER LWL0640 3P	POWER PCB	CN8	1
530000001115	CONNECTOR	WAFER LWL0640 5P	POWER PCB	CN10	1
530000000764	CONNECTOR	WAFER LWL0640 8P	POWER PCB	CN11	1
530000000797	STEREO JACK	EPJ-BBB-P 8mm	POWER PCB	J4	1
530000000796	PHONE JACK	EPJ-BNB-P(8) MONO	POWER PCB	J1	1
530000001101	TUBE SOCKET	GZC9-A	POWER PCB	V2	1
530000001237		 HEAT SINK 80X30X80 VT50	POWER PCB	HSK1064	1
530000001117		TUBE RETAINER SPRING SUS 1.0 PIE	POWER PCB		1
530000000782		EARTH RING TERMINAL	POWER PCB		2
530000000781		PCB SUPPORT 15MM	POWER PCB		7
530000000882		SUPPORT 30MM	POWER PCB		2
530000001207	DC FAN	 KF0510S5L-01	POWER PCB		1
530000001143	PCB ASS'Y	JACK PCB ASSY VT15/30			(1)

Part Number	Category	Part Name	Location	Reference	QTY
530000001254		MAIN PCB ASSY VT50/100			(1)
530000001252		POWER PCB ASSY VT50			(1)
530000001233		 MAIN CHASSIS VT50/100	CHASSIS		1
530000001238		FRONT PANEL	CHASSIS		1
530000001240		 REAR PANEL VT50(100V)	CHASSIS		(1)
530000001241		 REAR PANEL VT50(120V)	CHASSIS		(1)
530000001242		 REAR PANEL VT50(230V)	CHASSIS		(1)
530000001243		 REAR PANEL VT50(240V)	CHASSIS		(1)
530000001126		VOLUME KNOB ABS (CHIKEN HEAD) CLEAM	CHASSIS		8
530000001127		ROUND KNOB ABS - VT200	CHASSIS		3
530000000206		LED BUSHING	CHASSIS		1
530000000839		RUBBER BUSHING PAI12	CHASSIS		1
530000001215	POWERTRANS	 TRANS 100V = 076-VT50J	CHASSIS		(1)
530000001216	POWERTRANS	 TRANS 120V = 076-VT50U	CHASSIS		(1)
530000001217	POWERTRANS	 TRANS 220-230V = 076-VT50E	CHASSIS		(1)
530000001218	POWERTRANS	 TRANS 240V = 076-VT50EF	CHASSIS		(1)
530000000170	FUSE	 T1.6AL 250V	CHASSIS	100V,120V	(1)
530000000169	FUSE	 T800mA L 250V	CHASSIS	230V,240V	(1)
530000000832	POWER SWITCH	 APS-1101HV0(RL3-111)	CHASSIS		1
530000000199	INLET/FUSE HOLDER	 SC-8F-21	CHASSIS		1
530000000282	TUBE	12AX7EH	CHASSIS		1
530000001259		CHASSIS ASS'Y(100V)			(1)
530000001260		CHASSIS ASS'Y(120V)			(1)
530000001261		CHASSIS ASS'Y(230V)			(1)
530000001262		CHASSIS ASS'Y(240V)			(1)
530000001224	SPEAKER	TSL300G0505			1
530000001267		 CABINET ASS'Y VT50			1
530000000313		 HANDLE ASS'Y			1
530000000138		VOX (LARGE) SILVER		BRAND MARK	1
530000000160		VALVETRONICS SILVER		EMBLEM	1
530000001234		SPEAKER GRILL VT50			1
530000000283		Vent Grill ABS			3
530000000252		RUBBER FOOT SBR SMALL			4
530000000146		CORNER NYLON 6/6 COR0012-A			8
530000000254		SCREW CAP ABS			10
530000000875		RUBBER SPONGE 150X5X2T			2
530000000878		RUBBER SPONGE 70X10X2T			3
500600006508	AC CORD	 100V = LY100JPVCTFLY35LY37			(1)
530000000123	AC CORD	 120V = KKP30-16A			(1)
530000000124	AC CORD	 230V = KKP4819R-16A		GE	(1)
530000000125	AC CORD	 230V = KKP650-16A		UK	(1)
530000000126	AC CORD	 240V = KKP550-16A			(1)
500540028903	ADAPTER PLUG	 YL-212		100JP	(1)